

BS LIGHT



ILUMINANDO
TU CAMINO
LIGHTING
YOUR WAY

BSLIGHT



ÍNDICE

INDEX

01

BOMBILLAS / BULBS

- 5/ · Bombilla BA9s multiled / BA9s multiled bulbs
- 6/ · Piloto 5mm / 5mm pilot
- 7/ · Piloto 22mm multiled / multiled 22mm pilot
- 8/ · Bombillas Bi-pin / Bi-pin Bulbs
- Bombillas dicroicas / Dichroic Bulbs
 - 9/ · MR16 3 LEDS de 1W / MR16 bulbs with 3 LEDS of 1W
 - 10/ · MR16 3 LEDS de 2W / MR16 bulbs with 3 LEDS of 2W
 - 11/ · MR16 3 LEDS de 3W / MR16 bulbs with 3 LEDS of 3W
 - 12/ · Bombillas dicroicas COB / Dichroic COB Bulbs
 - 13/ · Bombillas MR16 RGB / MR16 RGB bulbs
- 14/ · Bombillas lineales / R7s bulbs
- 15/ · Bombillas E27 / E27 bulbs
- 16/ · Bombillas AR111 / AR111 Bulbs
- 17/ · Bombillas PAR30 y PAR38 / PAR30 and PAR38 bulbs
- 18/ · Bombillas PL / PL bulbs
- 19/ · Bombillas E40 28W / E40 bulbs 28W
- 20/ · Bombillas E40 54W / E40 bulbs 54W
- 21/ · Bombillas PAR56 / PAR56 bulbs
- 22/ · Tubo LED / LED tub

02

MÓDULOS, TIRAS Y PERFILES / STRIPS AND PROFILES

- Módulos LED / Modules
 - 24/26 · Módulo 2, 3, 4 LEDS / 2,3,4 LEDS modules
 - 27/ · Módulo 3 LEDS RGB / 3 LEDS modules RGB
- 28/ · Tira rígida de 30 LEDS SMD / 30 LEDS SMD rigid strip
- Tiras flexibles LED / Flexible strips
 - 29/ · Tiras flexibles monocolor 300 LEDS 3528 IP33 / Flexible strips 300 LEDS 3528 IP33
 - 30/ · Tiras flexibles monocolor 300 LEDS 3528 IP66 / Flexible strips 300 LEDS 3528 IP66
 - 31/ · Tiras flexibles monocolor 300 LEDS 3528 IP68 / Flexible strips 300 LEDS 3528 IP68
 - 32/ · Tiras flexibles monocolor 300 LEDS 3528 IP33 asimétrica 90° / Flexible strips 300 LEDS 3528 IP33 asymeric 90°
 - 33/ · Tiras flexibles monocolor 300 LEDS 3528 IP66 asimétrica 90° / Flexible strips 300 LEDS 3528 IP66 asymeric 90°
 - 34/ · Tiras flexibles monocolor 600 LEDS 3528 IP33 / Flexible strips 600 LEDS 3528 IP33
 - 35/ · Tiras flexibles monocolor 600 LEDS 3528 IP66 / Flexible strips 600 LEDS 3528 IP66
 - 36/ · Tiras flexibles monocolor 600 LEDS 3528 IP68 / Flexible strips 600 LEDS 3528 IP68
 - 37/ · Tiras flexibles monocolor 1200 LEDS 3528 IP33 / Flexible strips 1200 LEDS 3528 IP33
 - 38/ · Tiras flexibles monocolor 1200 LEDS 3528 IP66 / Flexible strips 1200 LEDS 3528 IP66
 - 39/ · Tiras flexibles monocolor 1200 LEDS 3528 IP68 / Flexible strips 1200 LEDS 3528 IP68
 - 40/ · Tiras flexibles monocolor 150 LEDS 5050 IP33 / Flexible strips 150 LEDS 5050 IP33
 - 41/ · Tiras flexibles monocolor 150 LEDS 5050 IP66 / Flexible strips 150 LEDS 5050 IP66
 - 42/ · Tiras flexibles monocolor 150 LEDS 5050 IP68 / Flexible strips 150 LEDS 5050 IP68
 - 43/ · Tiras flexibles monocolor 300 LEDS 5050 IP33 / Flexible strips 300 LEDS 5050 IP33
 - 44/ · Tiras flexibles monocolor 300 LEDS 5050 IP66 / Flexible strips 300 LEDS 5050 IP66
 - 45/ · Tiras flexibles monocolor 300 LEDS 5050 IP68 / Flexible strips 300 LEDS 5050 IP68
 - 46/ · Tiras flexibles dual 300 LEDS 5050 blanco frío + blanco cálido / Dual flexible strips
 - 47/ · Tiras flexibles 160 LEDS 5050 serie SMART / Smart flexible strips
- 48/ · Conectores y empalmes sin soldadura / Connectors and junctions
- 48/ · Termorretráctil con silicona / Heat shrinking tube with silicone
- Perfiles LED / LED profile
 - 49/ · Perfil de aluminio redondo / Round aluminum profile
 - 49/ · Perfil de aluminio esquinera / Corner aluminum profile
 - 50/ · Perfil de aluminio estanco / Waterproof aluminum profile
 - 50/ · Perfil de aluminio con canal / Aluminum profile with channel
 - 51/ · Perfil de aluminio esquinera cuadrado / Aluminum squire corner profile
 - 51/ · Perfil de aluminio esquinera redondo / Aluminum round corner profile
 - 52/ · Perfil de aluminio empotrable mini / Mini recessed aluminum profile
 - 52/ · Perfil de aluminio superficie mini / Mini surface aluminum profile
 - 53/ · Perfil de aluminio empotrable estándar / Aluminum standard recessed profile
 - 53/ · Perfil de aluminio superficie estándar / Aluminum standard surface profile
 - 54/ · Perfil de aluminio 16mm con óptica / 16mm aluminum profile with optic
 - 54/ · Perfil de aluminio 16mm redondo / 16mm round aluminum profile
 - 55/ · Perfil de aluminio 16mm cuadrado / 16mm square aluminum profile
 - 55/ · Perfil de aluminio serie ELH / ELH aluminum profile

03

FUENTES Y CONTROLADORES / DRIVERS AND CONTROLLERS

- 57/ · Fuentes de corriente constante / Constant current drivers
- 58/ · Fuentes de tensión constante para interior / Indoor constant tension driver
- 59/ · Fuentes de tensión constante para exterior / Outdoor constant tension driver
- 60/ · Controladores RGB / RGB controllers
- 61/ · Amplificador RGB / RGB amplifier
- Reguladores / Dimmers
 - 62/ · Reguladores monocolor PWM / Single-color PWM dimmers
 - 63/ · Reguladores 0-10V / 0-10V dimmers
 - 64/ · Reguladores DALI / DALI dimmers
- 65/ · Controladores WIFI para Iphone, Ipad o Android / Wifi controllers for Iphone, Ipad or Android
- 66/ · Panel táctil mural / Touch panel mural
- DMX / DMX
 - 67/ · Decodificador DMX / DMX decoder
 - 68/ · Interface USB-DMX / USB-DMX Interface
 - 69/ · Interface USB-DMX panel táctil / Touch panel USB-DMX Interface
- 70/ · Sensores presencia y contacto / Presence and contact sensors

04

ILUMINACIÓN EXTERIOR / OUTDOOR LIGHTING

- Aplique de pared / Wall lamps
 - 72/ · Aplique de pared serie NAS / NAS wall lamps series
 - 73/ · Aplique de pared serie TRES / TRES wall lamps series
 - 74/ · Apliques de pared serie JULIE / JULIE wall lamps series
- Familia serie LONDRES / LONDRES lighting series
- Familia serie PARIS / PARIS lighting series
- Mini empotrables de señalización / Mini recessed signaling-light
- Empotrable de pared / Recessed wall
 - 78/ · Empotrable de pared / Recessed wall
 - 79/ · Empotrable de pared rectangular / Rectangular recessed wall
- Empotrable de suelo / Recessed inground
 - 80/ · Empotrable de suelo 55mm / Recessed inground 55mm
 - 81/ · Empotrable de suelo 116mm / Recessed inground 116mm
 - 82/ · Empotrable de suelo 173mm / Recessed inground 173mm
- Bañador de pared / Wall washer
- 84/ · Piquetas de jardín / Garden spikes
- Proyectores / Flood Light
 - 85/ · Proyectores de jardín / Garden spotlight
 - 86/ · Proyectores de jardín alta potencia / High power outdoor spotlight
 - 87/ · Proyectores sumergibles / Waterproof spotlight
- Empotrable sumergible / Waterproof recessed
 - 88/ · Empotrable sumergible 67mm / Waterproof recessed 67mm
 - 89/ · Empotrable sumergible 150mm / Waterproof recessed 150mm
 - 90/ · Empotrable sumergible 180mm / Waterproof recessed 180mm
 - 91/ · Empotrable sumergible rectangular / Waterproof recessed rectangular
- Mini proyectores para piscina / Mini spotlight for swimming pool
- 93/ · Proyectores para piscina / Swimming pool spotlight

05

ILUMINACIÓN INTERIOR / INDOOR LIGHTING

- 95/ · Paneles LED / Round LED panel
- 96/ · Paneles LED / LED panel
- Aros y downlight / Mini downlight and downlight
 - 97/ · Aro ultrafino / Ultrafine rings
 - 98/ · Aros empotrar / Recessed rings
 - 99/ · Aros empotrar COB / Downlight COB
 - 100/ · Aros empotrar COB orientables / Ajustable downlight COB
 - 101/ · Downlight profesional / Profesional downlight
- 102/ · Foco de carril profesional / Profesional tracklight
- 103/ · Luminaria tipo Cardan / Recessed lumina

06

ILUMINACIÓN INDUSTRIAL-URBANO / INDUSTRIAL LIGHTING

- Campanas industriales / High bay light
 - 105/ · Campanas industriales hasta 100W / High bay Light to 100W
 - 106/ · Campanas industriales hasta 200W / High bay Light to 200W
- Proyectores / Flood Light
 - 107/ · Proyector hasta 50W / Flood Light to 50W
- Luminarias Urbanas / Street Lighting
 - 108/ · Luminaria Urbana 56W / Street Lighting 56W
 - 109/ · Luminaria Urbana 98W / Street Lighting 98W
 - 110/ · Luminaria Urbana 126W / Street Lighting 126W

07

CONSEJOS TÉCNICOS E ICONOS / TECHNICAL NOTES AND ICONS

01

BOMBILLAS

BULBS



6/

BOMBILLAS BA9s MULTILED BA9s MULTILED BULBS

Bombillas BA9s multiled para su inserción en cualquier casquillo BA9s.
BA9s multiled bulbs to be placed in any BA9s socket.

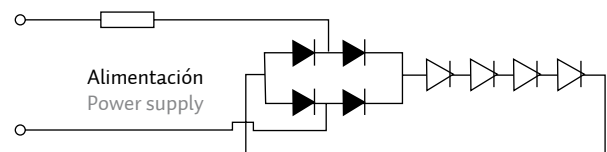
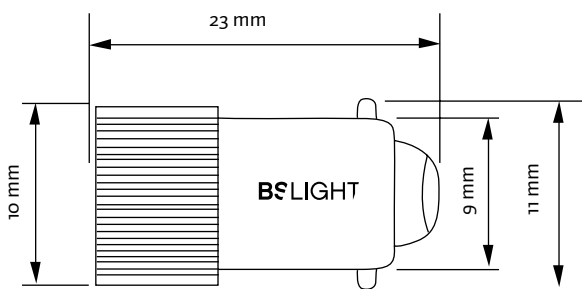

REFERENCIA REFERENCE	COLOR COLOR	ALIMENTACIÓN POWER SUPPLY	LUMINOSIDAD BRIGHTNESS
BA9SLED24R	Red	24V AC/DC	2000cd/m2
BA9SLED24V	Green	24V AC/DC	1500cd/m2
BA9SLED24B	White	24V AC/DC	2450cd/m2
BA9SLED24A	Yellow	24V AC/DC	2700cd/m2
BA9SLED24AZ	Blue	24V AC/DC	850cd/m2
BA9SLED48R	Red	48V AC	2000cd/m2
BA9SLED48V	Green	48V AC	1500cd/m2
BA9SLED48B	White	48V AC	2450cd/m2
BA9SLED48A	Yellow	48V AC	2700cd/m2
BA9SLED48AZ	Blue	48V AC	850cd/m2

REFERENCIA REFERENCE	COLOR COLOR	ALIMENTACIÓN POWER SUPPLY	LUMINOSIDAD BRIGHTNESS
BA9SLED110R	Red	110V AC	600cd/m2
BA9SLED110V	Green	110V AC	900cd/m2
BA9SLED110B	White	110V AC	2300cd/m2
BA9SLED110A	Yellow	110V AC	950cd/m2
BA9SLED110AZ	Blue	110V AC	500cd/m2
BA9SLED220R	Red	230V AC	460cd/m2
BA9SLED220V	Green	230V AC	850cd/m2
BA9SLED220B	White	230V AC	1200cd/m2
BA9SLED220A	Yellow	230V AC	550cd/m2
BA9SLED220AZ	Blue	230V AC	330cd/m2



7/

PILOTO 5MM 5MM PILOT

Piloto 5 mm con mirilla cromo y cable de alimentación.
5 mm Pilot with sight hole and power supply wire.

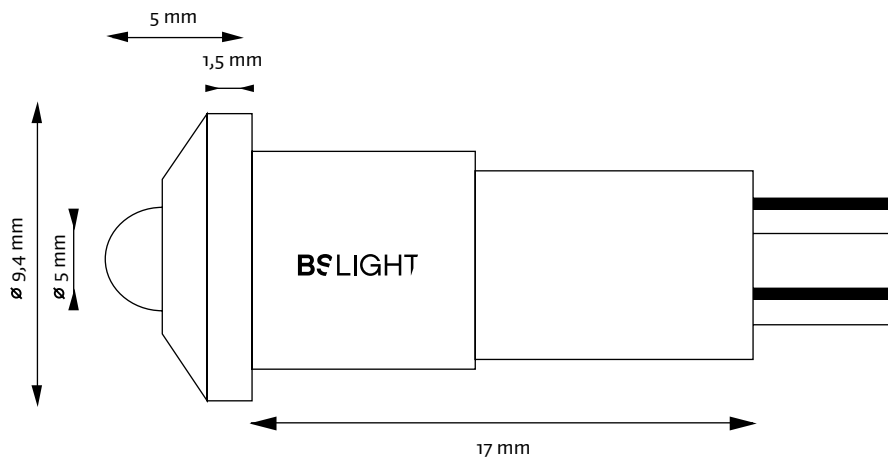

REFERENCIA REFERENCE	COLOR COLOR	TIPO DE LED LED TYPE	ALIMENTACIÓN POWER SUPPLY	DIÁMETRO DIAMETER	CABLE WIRE
L26012BPC	White	5mm 16.000mcd	12V DC	8mm	40cm
L260230BPC	White	5mm 16.000mcd	230V AC	8mm	40cm
L26012BPC-60	White	5mm 16.000mcd	12V DC	8mm	60cm
L260230BPC-60	White	5mm 16.000mcd	230V AC	8mm	60cm
L26012BPC-230	White	5mm 16.000mcd	12V DC	8mm	230cm
L260230BPC-230	White	5mm 16.000mcd	230V AC	8mm	230cm



8/

PILOTOS 22MM MULTILED MULTILED 22MM PILOTS

Piloto multiled en plástico para su colocación en taladros estándar de 22 mm.
Plastic multiled pilots to be placed in standard 22 mm drills.

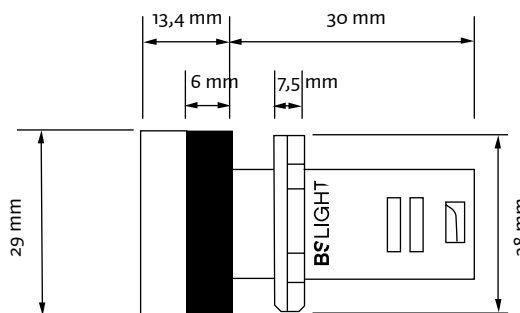

REFERENCIA REFERENCE	COLOR COLOR	ALIMENTACIÓN POWER SUPPLY	REFERENCIA REFERENCE	COLOR COLOR	ALIMENTACIÓN POWER SUPPLY
HD16-22D/S-AZ-12	■	12V AC/DC	HD16-22D/S-R-48	■	48V AC
HD16-22D/S-A-12	■	12V AC/DC	HD16-22D/S-V-48	■	48V AC
HD16-22D/S-B-12	■	12V AC/DC	HD16-22D/S-AZ-110	■	110V AC
HD16-22D/S-R-12	■	12V AC/DC	HD16-22D/S-A-110	■	110V AC
HD16-22D/S-V-12	■	12V AC/DC	HD16-22D/S-B-110	■	110V AC
HD16-22D/S-R-24	■	24V AC/DC	HD16-22D/S-R-110	■	110V AC
HD16-22D/S-V-24	■	24V AC/DC	HD16-22D/S-V-110	■	110V AC
HD16-22D/S-B-24	■	24V AC/DC	HD16-22D/S-R-230	■	230V AC
HD16-22D/S-AZ-24	■	24V AC/DC	HD16-22D/S-V-230	■	230V AC
HD16-22D/S-A-24	■	24V AC/DC	HD16-22D/S-B-230	■	230V AC
HD16-22D/S-AZ-48	■	48V AC	HD16-22D/S-AZ-230	■	230V AC
HD16-22D/S-A-48	■	48V AC	HD16-22D/S-A-230	■	230V AC
HD16-22D/S-B-48	■	48V AC			



9/

BOMBILLAS BI-PIN BI-PIN BULBS

Bombilla con casquillo G4, G9 y GX53 para sustitución directa de las Bi-pin halógenas.
Bulb with G4, G9 and GX53 socket for direct replacement from the halogen Bi-pin.



G4

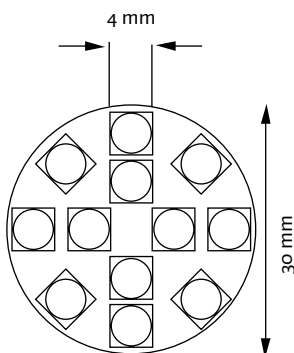

G9

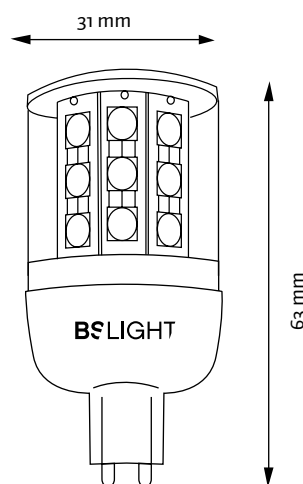

GX53

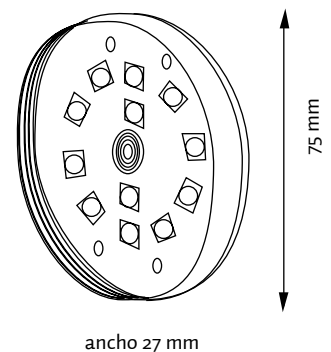

REFERENCIA REFERENCE	COLOR COLOR	TEMP. TEMP.	TIPO LED LED TYPE	ALIMENTACIÓN POWER SUPPLY	CASQUILLO SOCKET	FLUJO LUM. LUM. FLOW	ÁNGULO ANGLE	CONSUMO CONSUME
G4-12BC	Yellow	3000°K	12 LEDS 5050	12V	G4	160lm	120°	2,4W
G4-12BF	White	6000°K	12 LEDS 5050	12V	G4	180lm	120°	2,4W
G9-21BC	Yellow	3000°K	21 LEDS 5050	220-240V AC	G9	300lm	120°	4W
G9-21BF	White	6000°K	21 LEDS 5050	220-240V AC	G9	320lm	120°	4W
GX53-9BC	Yellow	3000°K	30 LEDS 5050	220-240V AC	GX53	480lm	120°	9W
GX53-9BF	White	6000°K	30 LEDS 5050	220-240V AC	GX53	500lm	120°	9W



GX5-3



GU10



E27

10 /

BOMBILLAS MR16 3 LEDS DE 1W MR16 BULBS WITH 3 LEDS OF 1W

Bombillas dicroicas MR16 3 LEDS de 1W de la marca Cree montado en óptica de 30°. Casquillos disponibles GX5,3, GU10 y E27.
MR16 dichroic bulbs with 3 LEDS of 1W Cree brand. Beam angle 30°. GX5,3, GU10 and E27 sockets.



GX5-3

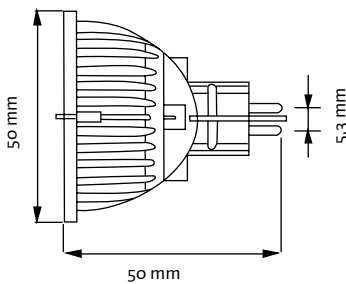

GU10

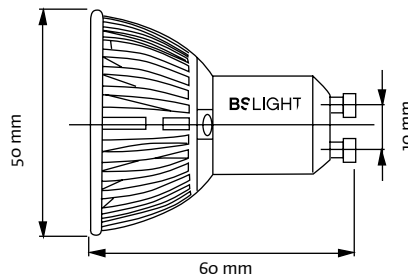

E27

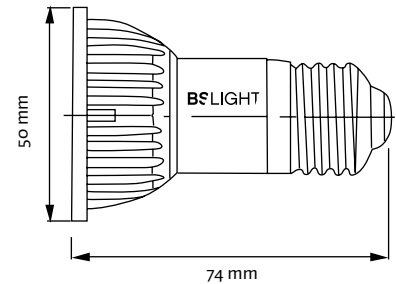

REFERENCIA REFERENCE	COLOR COLOR	TEMPERATURA TEMPERATURE	ALIMENTACIÓN POWER SUPPLY	CASQUILLO SOCKET	FLUJO LUM. LUM. FLOW
MR163X1WBF	White	6000°K	12V DC	GX5.3	190lm
MR163X1WBC	Yellow	3000°K	12V DC	GX5.3	150lm
MR163X1WBD	White	4000°K	12V DC	GX5.3	170lm
MR163X1WBFGU10	White	6000°K	230V AC	GU10	190lm
MR163X1WBCGU10	Yellow	3000°K	230V AC	GU10	150lm
MR163X1WBDBGU10	White	4000°K	230V AC	GU10	170lm
MR163X1WBFE27	White	6000°K	230V AC	E27	190lm
MR163X1WBCE27	Yellow	3000°K	230V AC	E27	150lm



GU10

GX5.3

11 /

BOMBILLAS MR16 DE 3 LEDS DE 2W MR16 BULBS 3 LEDS OF 2W

Bombilla formato MR16 con 3 LEDS HP de 2W con casquillo GX5.3 a 12V o GU10 a 230V.

MR16 bulbs with 3 LEDS 2W HP with sockets GX5,3 for 12V and GU10 for 230V.



GU10

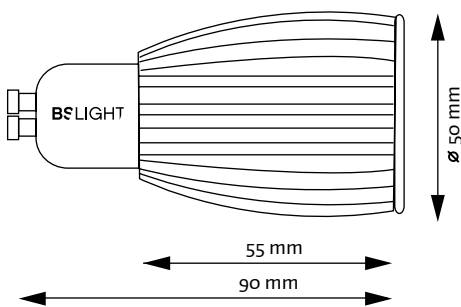

GX5.3

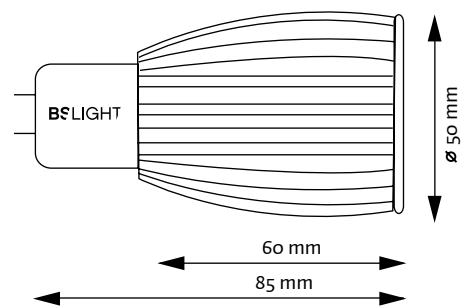
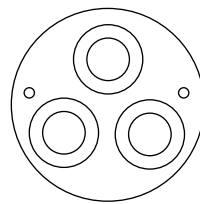

REFERENCIA REFERENCE	COLOR COLOR	TEMPERATURA TEMPERATURE	TIPO LED LED TYPE	ALIMENTACIÓN POWER SUPPLY	FLUJO LUM. LUM. FLOW	CASQUILLO SOCKET
MR163X2WBF	White	6000°K	3 LEDS 2W	12V DC	450lm	GX5.3
MR163X2WBC	Yellow	3000°K	3 LEDS 2W	12V DC	430lm	GX5.3
MR163X2WBD	Light Yellow	4000°K	3 LEDS 2W	12V DC	450lm	GX5.3
MR163X2WBFGU10	White	6000°K	3 LEDS 2W	230V AC	450lm	GU10
MR163X2WBCGU10	Yellow	3000°K	3 LEDS 2W	230V AC	430lm	GU10
MR163X2WBDBGU10	Light Yellow	4000°K	3 LEDS 2W	230V AC	450lm	GU10



GU10

GX5.3

12 /

BOMBILLAS MR16 DE 3 LEDS DE 3W MR16 BULBS WITH 3 LEDS OF 3W

Bombilla formato MR16 con 3 LEDS HP de 3W con casquillo GX5.3 a 12V o GU10 a 230V.

MR16 bulbs with 3 LEDS 3W HP with sockets GX5,3 for 12V and GU10 for 230V.



GU10

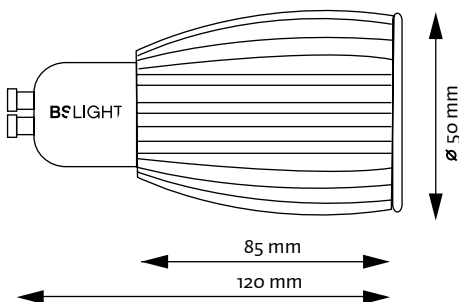

GX5.3

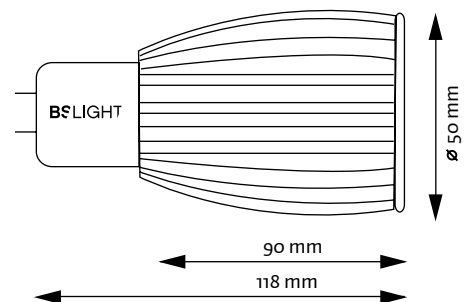

REFERENCIA REFERENCE	COLOR COLOR	TEMPERATURA TEMPERATURE	TIPO LED LED TYPE	ALIMENTACIÓN POWER SUPPLY	FLUJO LUM. LUM. FLOW	CASQUILLO SOCKET
MR163X3WBF	White	6000°K	3 LEDS 3W	12V DC	340lm	GX5.3
MR163X3WBC	Yellow	3000°K	3 LEDS 3W	12V DC	320lm	GX5.3
MR163X3WBD	White	4000°K	3 LEDS 3W	12V DC	340lm	GX5.3
MR163X3WBF GU10	White	6000°K	3 LEDS 3W	230V AC	340lm	GU10
MR163X3WBC GU10	Yellow	3000°K	3 LEDS 3W	230V AC	320lm	GU10
MR163X3WBD GU10	White	4000°K	3 LEDS 3W	230V AC	340lm	GU10



13 /

BOMBILLAS DICROICAS COB DICHROIC COB BULBS

Bombillas tipo dicroica con casquillo GU10 con tecnología de LED COB para sustitución directa de las tradicionales halógenas con este casquillo.

Dichroic bulbs COB LED technology GU10 socket for direct replacement of traditional halogen lamp socket.



3 W

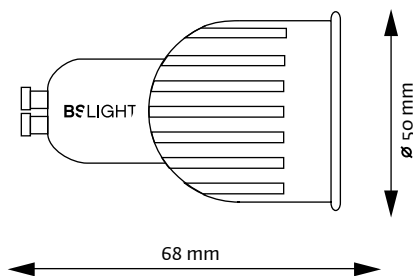

5 W 7W 9W

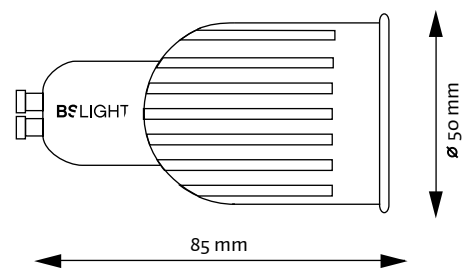

REFERENCIA REFERENCE	COLOR COLOR	TEMPERATURA TEMPERATURE	TIPO LED LED TYPE	ALIMENTACIÓN POWER SUPPLY	CASQUILLO SOCKET	FLUJO LUM. LUM. FLOW	CONSUMO CONSUME
GU10-COB-3WBF	White	6000°K	COB 3W	85-250V AC	GU10	300lm	5W
GU10-COB-3WBC	Yellow	3000°K	COB 3W	85-250V AC	GU10	280lm	5W
GU10-COB-5WBF	White	6000°K	COB 5W	85-250V AC	GU10	400lm	6,5W
GU10-COB-5WBC	Yellow	3000°K	COB 5W	85-250V AC	GU10	380lm	6,5W
GU10-COB-7WBF	White	6000°K	COB 7W	85-250V AC	GU10	580lm	8,5W
GU10-COB-7WBC	Yellow	3000°K	COB 7W	85-250V AC	GU10	560lm	8,5W
GU10-COB-9WBF	White	6000°K	COB 9W	85-250V AC	GU10	700lm	10,5W
GU10-COB-9WBC	Yellow	3000°K	COB 9W	85-250V AC	GU10	680lm	10,5W



BOMBILLA MR16 RGB

MR16 RGB BULBS

Bombilla dicroica con LED 3W RGB. La referencia incluye un mando IR multifunciones. Con el mando se pueden controlar todas las bombillas que estén al alcance del infrarrojo.

Dichroic bulbs 3W LED RGB. Remote control Infra-red and multifunction included. The remote control can control all the bulbs that can be reached by the infra-red.

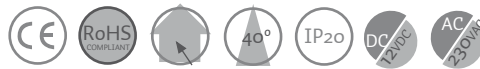

GX5.3

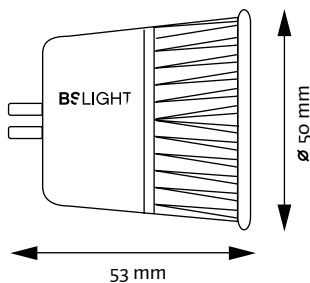

GU10

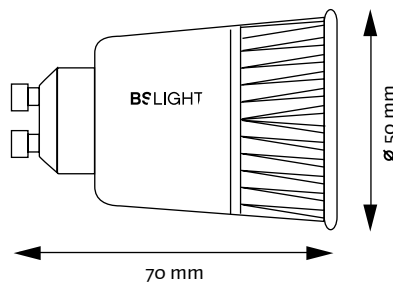

E27

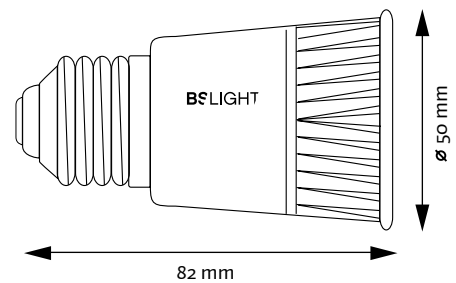

REFERENCIA REFERENCE	COLOR COLOR	TIPO LED LED TYPE	ALIMENTACIÓN POWER SUPPLY	CASQUILLO SOCKET	FLUJO LUM. LUM. FLOW
MR16RGB-3W		RGB 3W	12V DC	GX5,3	BF 150lm
MR16RGB-3W-GU10		RGB 3W	230V AC	GU10	BF 150lm
MR16RGB-3W-E27		RGB 3W	230V AC	E27	BF 150lm



R7S-118BC



R7S-78BC

15 /

BOMBILLAS LINEALES R7s BULBS

Bombillas lineales con casquillo R7s para sustitución directa de las tradicionales halógenas lineales con este casquillo.
R7s linear bulb bushing for direct replacement of the traditional linear halogen lamp socket.

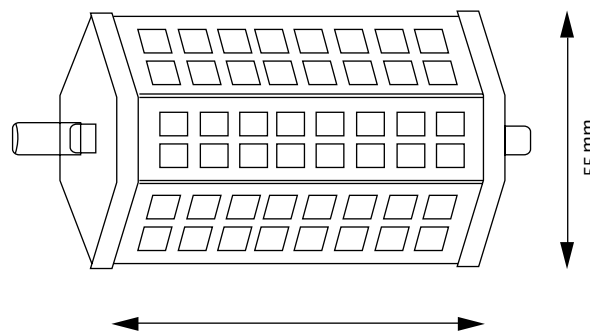

R7S-78BC=78mm
R7S-118BC=118mm
R7S-189BC=189mm

REFERENCIA REFERENCE	COLOR COLOR	TEMP. TEMP.	TIPO LED LED TYPE	ALIMENTACIÓN POWER SUPPLY	CASQUILLO SOCKET	FLUJO LUM. LUM. FLOW	MEDIDAS MEASURE	CONSUMO CONSUME
R7S-78BC	—	3000°K	18 LEDS 5050	100-240V AC	R7s	320lm	78x55mm	4W
R7S-118BC	—	3000°K	42 LEDS 5050	100-240V AC	R7s	720lm	118x55mm	10W
R7S-189BC	—	3000°K	72 LEDS 5050	100-240V AC	R7s	1200lm	189x55mm	15W



16 /

BOMBILLAS E27 E27 BULBS

Bombillas con casquillo E27 para sustitución directa de las tradicionales de incandescencia.

E27 bulbs to replace the traditional incandescence bulbs.

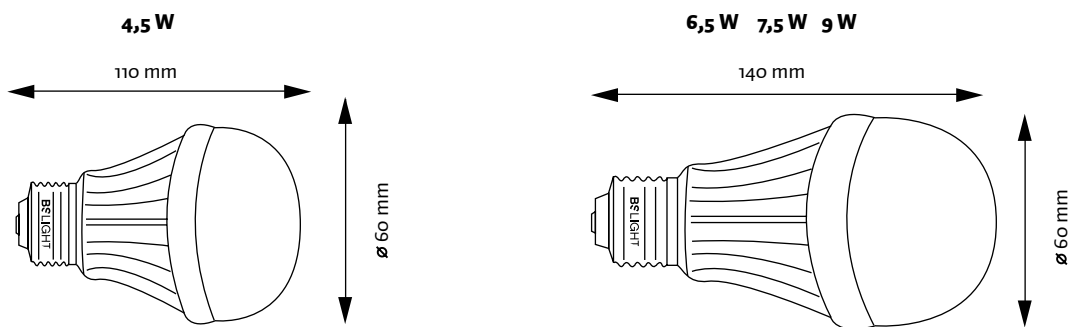

REFERENCIA REFERENCE	COLOR COLOR	TEMP. TEMP.	TIPO LED LED TYPE	ALIMENTACIÓN POWER SUPPLY	CASQUILLO SOCKET	FLUJO LUM. LUM. FLOW	ÁNGULO ANGLE	CONSUMO CONSUME
E27-4,5W-BC	Yellow	3000°K	3014	110-230V AC	E27	320lm	150°	5W
E27-4,5W-BD	Light Yellow	4000°K	3014	110-230V AC	E27	340lm	150°	5W
E27-4,5W-BF	White	6000°K	3014	110-230V AC	E27	360lm	150°	5W
E27-6,5W-BC	Yellow	3000°K	3014	110-230V AC	E27	450lm	150°	7W
E27-6,5W-BD	Light Yellow	4000°K	3014	110-230V AC	E27	470lm	150°	7W
E27-6,5W-BF	White	6000°K	3014	110-230V AC	E27	500lm	150°	7W
E27-7,5W-BC	Yellow	3000°K	3014	110-230V AC	E27	600lm	150°	8W
E27-7,5W-BD	Light Yellow	4000°K	3014	110-230V AC	E27	630lm	150°	8W
E27-7,5W-BF	White	6000°K	3014	110-230V AC	E27	650lm	150°	8W
E27-9W-BC	Yellow	3000°K	3014	110-230V AC	E27	700lm	150°	9,5W
E27-9W-BD	Light Yellow	4000°K	3014	110-230V AC	E27	750lm	150°	9,5W
E27-9W-BF	White	6000°K	3014	110-230V AC	E27	800lm	150°	9,5W



BOMBILLAS AR111 AR111 BULBS

Bombilla formato AR111 de 6 o 12W para sustitución directa de las halógenas del mismo formato. Funcionamiento a 12V AC/DC o 230VAC (GU10).

AR111 bulbs 6 and 12W to replace AR111 format halogen bulbs. Working at 12V AC/DC or 230VAC (GU10).

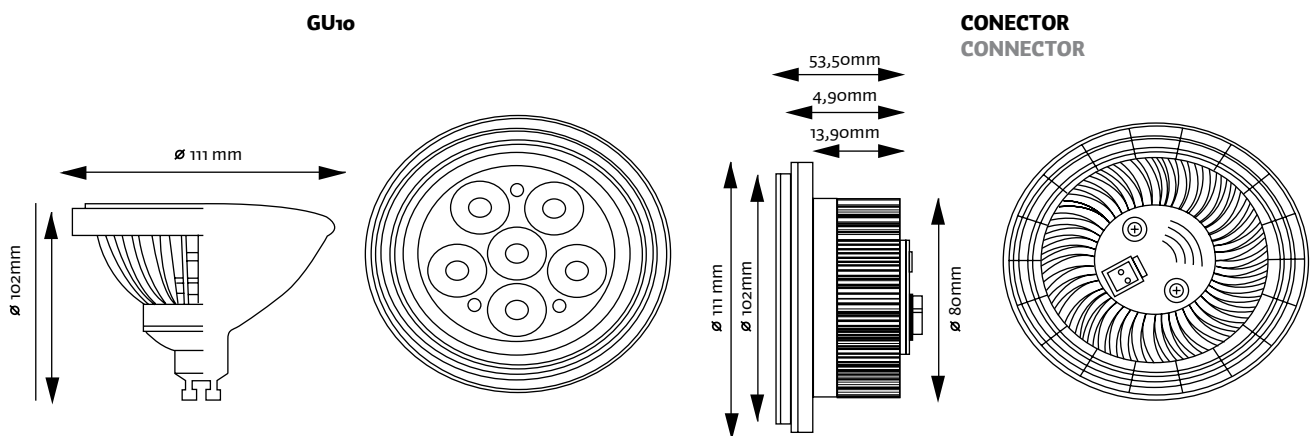
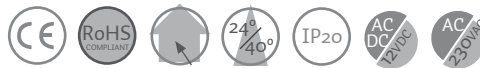

REFERENCIA REFERENCE	COLOR COLOR	TEMP. TEMP.	TIPO LED LED TYPE	ALIMENTACIÓN POWER SUPPLY	CASQUILLO SOCKET	FLUJO LUM. LUM. FLOW	ÁNGULO ANGLE
AR111-6BF	White	6000°K	6 LEDS 1W	12V AC/DC	Conector/ Connector	510lm	40°
AR111-6BC	Yellow	3000°K	6 LEDS 1W	12V AC/DC	Conector/ Connector	360lm	40°
AR111-12BF	White	6000°K	12 LEDS 1W	12V AC/DC	Conector/ Connector	1020lm	40°
AR111-12BC	Yellow	3000°K	12 LEDS 1W	12V AC/DC	Conector/ Connector	720lm	40°
AR111-12BF-24	White	6000°K	12 LEDS 1W	12V AC/DC	Conector/ Connector	1020lm	24°
AR111-12BC-24	Yellow	3000°K	12 LEDS 1W	12V AC/DC	Conector/ Connector	720lm	24°
AR111-12BF-GU10	White	6000°K	12 LEDS 1W	230V AC	GU10	1020lm	40°
AR111-12BC-GU10	Yellow	3000°K	12 LEDS 1W	230V AC	GU10	720lm	40°
AR111-12BF-24-GU10	White	6000°K	12 LEDS 1W	230V AC	GU10	1020lm	24°
AR111-12BC-24-GU10	Yellow	3000°K	12 LEDS 1W	230V AC	GU10	720lm	24°



12X1 W



7X1 W

BOMBILLAS PAR30 Y PAR38 PAR30 AND PAR38 BULBS

Bombillas PAR30 y PAR38 de 7 y 12 LEDs de 1W respectivamente de la marca Cree. Estructura de aluminio en color gris y casquillo E27.

PAR30 and PAR38 bulbs with 7 and 12 LEDs 1W Cree brand. Made in grey aluminum, socket E27.

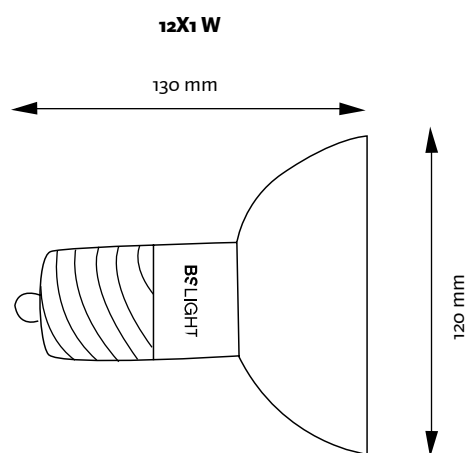
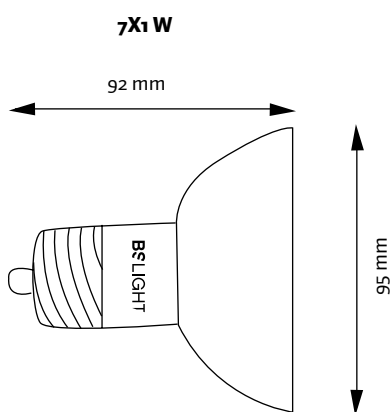

REFERENCIA REFERENCE	COLOR COLOR	TEMP. TEMP.	TIPO LED LED TYPE	ALIMENTACIÓN POWER SUPPLY	CASQUILLO SOCKET	FLUJO LUM. LUM. FLOW
PAR307X1BF	White	6000°K	7 LEDs 1W	230V AC	E27	385lm
PAR307X1BC	Yellow	3000°K	7 LEDs 1W	230V AC	E27	315lm
PAR3812X1BF	White	6000°K	12 LEDs 1W	230V AC	E27	660lm
PAR3812X1BC	Yellow	3000°K	12 LEDs 1W	230V AC	E27	540lm



19 /

BOMBILLAS PL PL BULBS

Bombilla PL con LED 5050 de 3, 9 y 13W. Alimentación directa a 230V AC.
PL bulbs with 5050 LED in 3,9 and 13W. Direct power supply 230V AC.

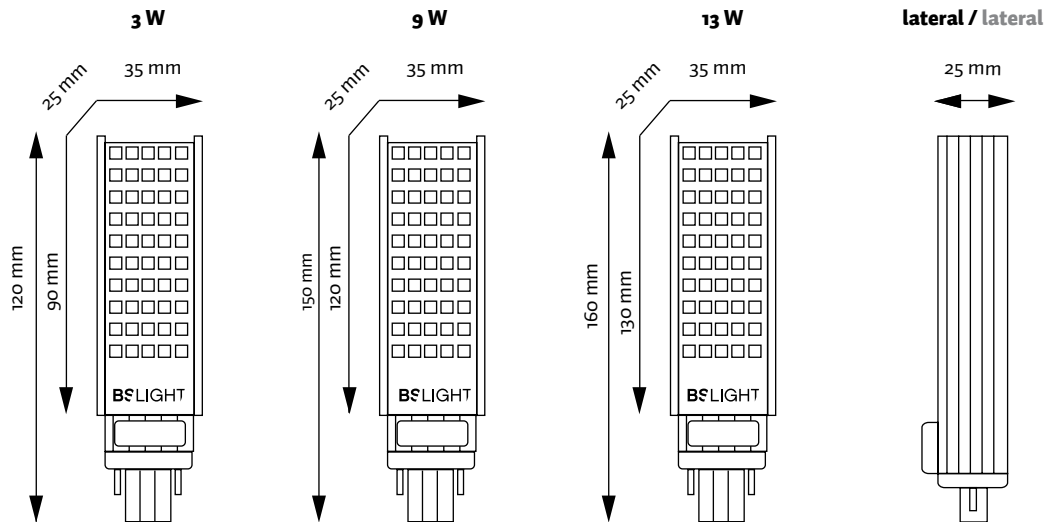

REFERENCIA REFERENCE	COLOR COLOR	TEMP. TEMP.	TIPO LED LED TYPE	ALIMENTACIÓN POWER SUPPLY	CASQUILLO SOCKET	FLUJO LUM. LUM. FLOW	CONSUMO CONSUME
PL-G24-3W-BC	Yellow	3000°K	15 LEDS 5050	85-230V AC	G24	210lm	3W
PL-G24-3W-BD	Yellow	4000°K	15 LEDS 5050	85-230V AC	G24	250lm	3W
PL-G24-3W-BF	White	6000°K	15 LEDS 5050	85-230V AC	G24	290lm	3W
PL-G24-9W-BC	Yellow	3000°K	40 LEDS 5050	85-230V AC	G24	520lm	9W
PL-G24-9W-BD	Yellow	4000°K	40 LEDS 5050	85-230V AC	G24	570lm	9W
PL-G24-9W-BF	White	6000°K	40 LEDS 5050	85-230V AC	G24	640lm	9W
PL-G24-13W-BC	Yellow	3000°K	60 LEDS 5050	85-230V AC	G24	980lm	13W
PL-G24-13W-BD	Yellow	4000°K	60 LEDS 5050	85-230V AC	G24	1080lm	13W
PL-G24-13W-BF	White	6000°K	60 LEDS 5050	85-230V AC	G24	1500lm	13W



BOMBILLAS E40 28W E40 BULBS 28W

Bombilla con casquillo E40 para sustitución directa en faros y báculos con este tipo de casquillo.
Alimentación directa a 230V AC.

E40 bulb for street lighting. Direct power supply 230V AC.

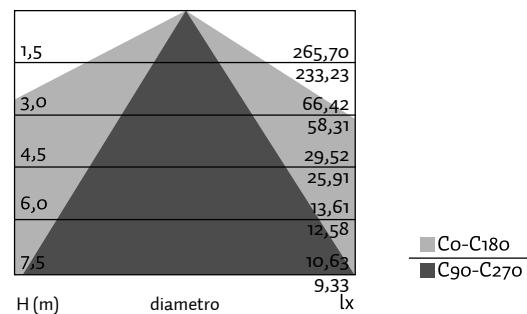
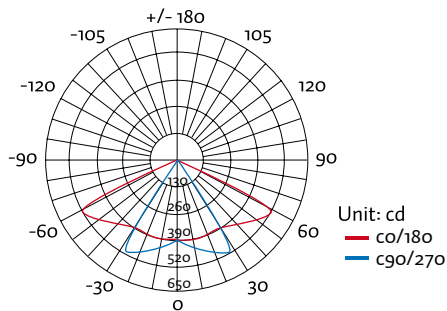
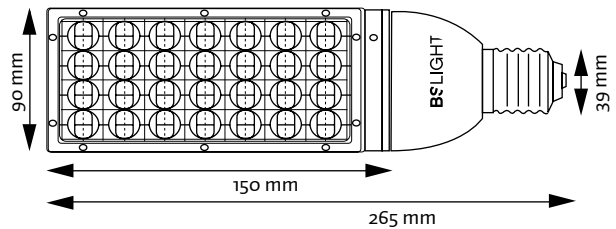
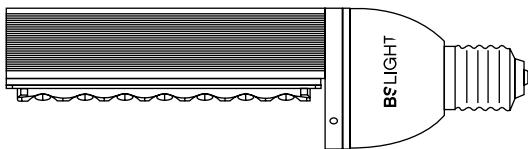

REFERENCIA REFERENCE	COLOR COLOR	ALIMENTACIÓN POWER SUPPLY	TIPO LED LED TYPE	FLUJO LUM. LUM. FLOW	CASQUILLO SOCKET	CONSUMO CONSUME
E40-28-BC	 	100-240V AC	28 LEDS 1W	2.100lm	E40	35W
E40-28-BF	 	100-240V AC	28 LEDS 1W	2.500lm	E40	35W



21 /

BOMBILLAS E40 54W E40 BULBS 54W

Bombilla con casquillo E40 de 54W para sustitución directa en faroles y báculos con este tipo de casquillo.
Alimentación directa a 230V AC.

E40 bulb for street lighting. Direct power supply 230V AC.

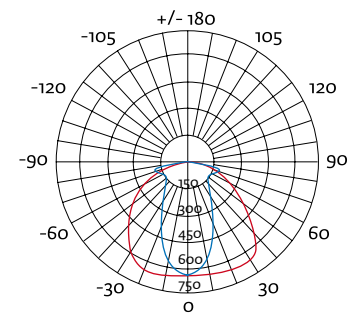
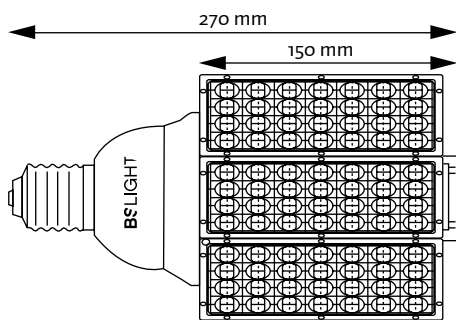

Unit: cd
 — Co/180
 — C90/270

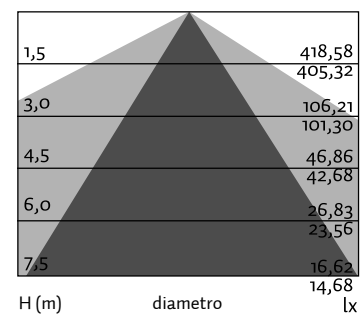
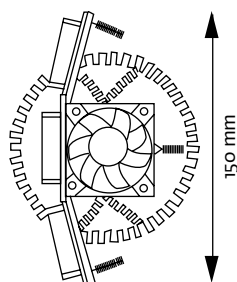

REFERENCIA REFERENCE	COLOR COLOR	ALIMENTACIÓN POWER SUPPLY	TIPO LED LED TYPE	FLUJO LUM. LUM. FLOW	CASQUILLO SOCKET	CONSUMO CONSUME
E40-54-BC	Yellow	100-240V AC	54 LEDs 1W	4.680lm	E40	60W
E40-54-BF	White	100-240V AC	54 LEDs 1W	5.100lm	E40	60W



22 /

BOMBILLA PAR56 PAR56 BULB

Bombillas en formato PAR56 de alta luminosidad o alta potencia. Insertadas en una carcasa de poliéster con una estanqueidad IP68 aptas para proyectores apropiados para este formato. Se puede reemplazar la bombilla tradicional de 300W por esta bombilla sin necesidad de realizar ningún cambio. Solo será necesario sustituir una por otra.

PAR56 bulbs high brightness or high power. Lamp body in waterproof polyester (IP68) suitable for swimming pool spotlights. The traditional 300W bulb can be replaced by the PAR56 without need to operate any change, just substitute one for the other.

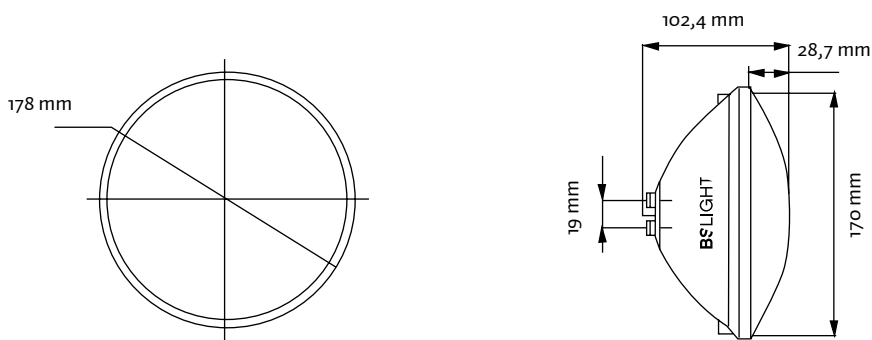

REFERENCIA REFERENCE	COLOR COLOR	ALIMENTACIÓN POWER SUPPLY	FRECUENCIA FREQUENCY	POTENCIA POWER	FLUJO LUM. LUM. FLOW	TIPO LED LED TYPE	CONTROL CONTROL	CASQUILLO SOCKET
RGB252LED		12V AC	50Hz	25W	900lm	252 LEDS 5mm	2 Cable / Wires	Tornillo / Screw
PAR56B252LED		12V AC	50Hz	25W	1200lm	195 LEDS 5mm	2 Cable / Wires	Tornillo / Screw
PAR56AZ252LED		12V AC	50Hz	25W	300lm	252 LEDS 5mm	2 Cable / Wires	Tornillo / Screw
PAR56R252LED		12V AC	50Hz	25W	500lm	252 LEDS 5mm	2 Cable / Wires	Tornillo / Screw
PAR56V252LED		12V AC	50Hz	25W	800lm	252 LEDS 5mm	2 Cable / Wires	Tornillo / Screw
HPAR56B		12V AC	50Hz	36W	1800lm	27 LEDS 1,2W	2 Cable / Wires	Tornillo / Screw
HPAR56RGB		12V AC	50Hz	36W	1600lm	24 LEDS 1,2W	2 Cable / Wires	Tornillo / Screw
PAR300W		12V AC	50Hz	300W	2200lm	Halógena / Halogen	2 Cable / Wires	Tornillo / Screw



23 /

TUBOS LED LED TUBE

Tubo LED en medidas y formatos como los fluorescentes tradicionales T5 y T8. No necesitan balastro ni cebador para su encendido. Conexión directa a 230V AC.

LED tube with the same size as the traditional Light T5 and T8. Does not need neither ballast nor starter for being switched on. Direct conection to 230 V AC.

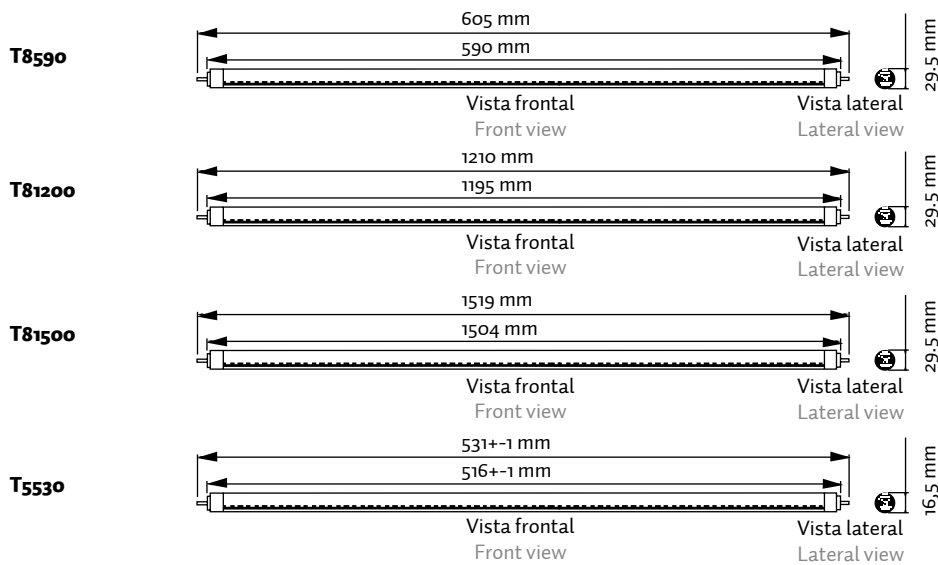

REFERENCIA REFERENCE	COLOR COLOR	ALIMENTACIÓN POWER SUPPLY	TIPO LED LED TYPE	EQUIVALENTE EQUIVALENCE	FLUJO LUM. LUM. FLOW	POTENCIA POWER
T8590	—	230V AC	160 LEDS 3528	T8 18W	820lm	9,6W
T81200	—	230V AC	270 LEDS 3528	T8 36W	1250lm	16W
T81500	—	230V AC	395 LEDS 3528	T8 58W	1500lm	22W
T5530	—	12V DC	75 LEDS 3528	T5 13W	420lm	4,5W

02

TIRAS Y PERFILES

LED STRIPS AND

PROFILES

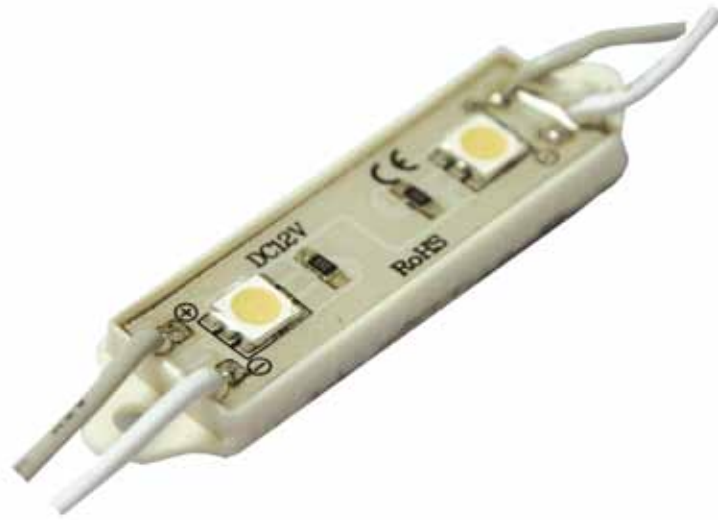

25 /

MÓDULO 2 LEDS

2 LEDS MODULES

Módulos de 2 LEDS tipo 5050 ideales para rotulación y letras corpóreas. Se entregan cableados en kits de 20 piezas. Se fijan mediante cinta adhesiva o tornillos.

Ideales para letras corpóreas o cajas de luz con un fondo de 8 a 18cm. Se pueden unir en serie un máximo de 50 Pcs.

Modules 2 LEDS 5050 for neon signs. Wire kits of 20 pieces included. The strip can be fixed with adhesive or screws.

Ideal for neon signs or lighting boxes of 8 to 18 cm deep. Until 50 Pcs can be connected in serie.

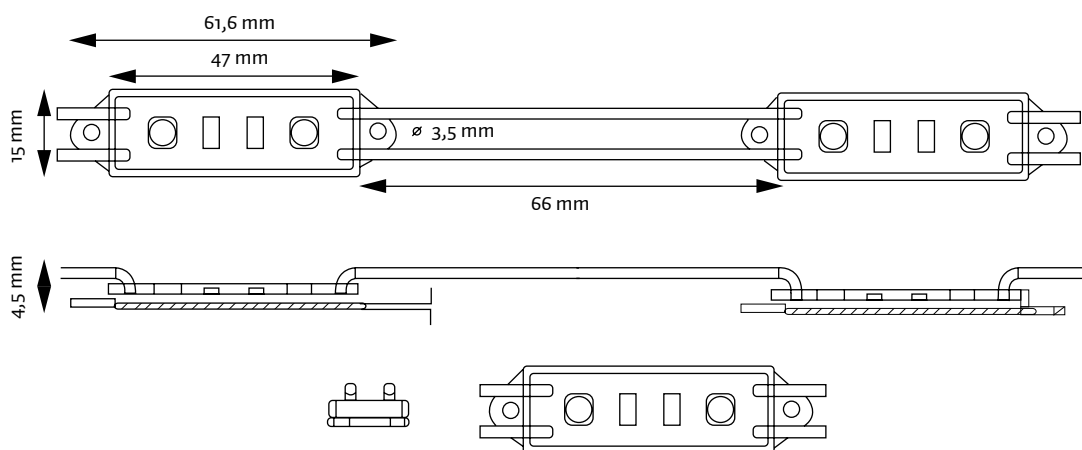

REFERENCIA	COLOR	TEMPERATURA	PROTECCIÓN	ALIMENTACIÓN	FLUJO LUM.	EFICIENCIA L.	ÁNGULO	CONSUMO
REFERENCE	COLOR	TEMPERATURE	PROTECTION	POWER SUPPLY	LUM. FLOW	EFFICIENCY	ANGLE	CONSUME
M2R	Red	620-630nm	IP 65	12V DC	12,2lm	25,4lm/W	115°	0,48W
M2AM	Yellow	512-528nm	IP 65	12V DC	9,6lm	20lm/W	115°	0,48W
M2AZ	Blue	463-475nm	IP 65	12V DC	6,4lm	13,3lm/W	115°	0,48W
M2V	Green	584-594nm	IP 65	12V DC	24lm	50lm/W	115°	0,48W
M2BF	White	6000°K	IP 65	12V DC	32lm	66,7lm/W	115°	0,48W
M2BC	Yellow	3000°K	IP 65	12V DC	32lm	66,7lm/W	115°	0,48W

Fuente de alimentación recomendada para 20 Pcs FT121,25 / Recommended power supply for 20 Pcs: FT121,25



26 /

MÓDULO 3 LEDS

3 LEDS MODULES

Módulos de 3 LEDS tipo 5050 ideales para rotulación y letras corpóreas. Se entregan cableados en kits de 20 piezas. Se fijan mediante cinta adhesiva o tornillos.

Ideales para letras corpóreas o cajas de luz con un fondo de 6 a 16cm. Se pueden unir en serie un máximo de 50 Pcs.

Modules 3 LEDS 5050 for neon signs. Wire kits of 20 pieces included. The strip can be fixed with adhesive or screws.

Ideal for neon signs or lighting boxes of 6 to 16 cm deep. Until 50 Pcs can be connected in serie.

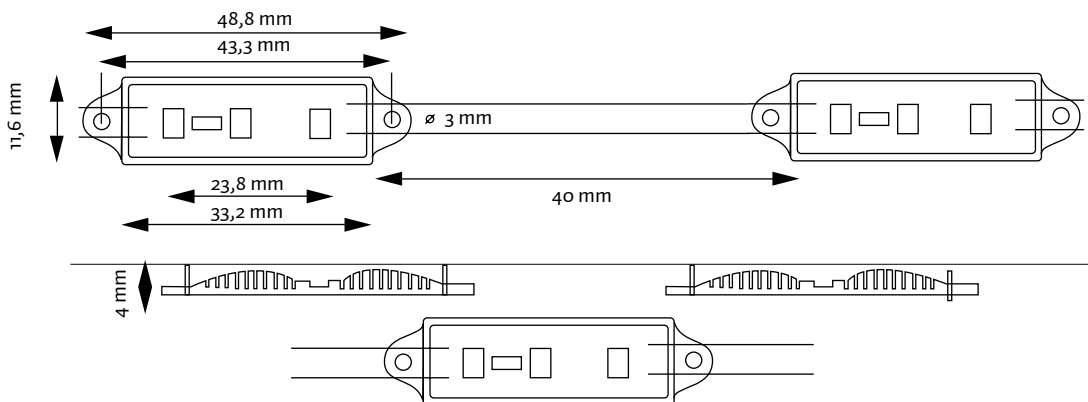

REFERENCIA	COLOR	TEMPERATURA	PROTECCIÓN	ALIMENTACIÓN	FLUJO LUM.	EFICIENCIA L.	ÁNGULO	CONSUMO
REFERENCE	COLOR	TEMPERATURE	PROTECTION	POWER SUPPLY	LUM. FLOW	EFFICIENCY	ANGLE	CONSUME
M3R	■	620-630nm	IP 65	12V DC	18,3lm	25,4lm/W	115°	0,72W
M3AM	■	512-528nm	IP 65	12V DC	14,4lm	20lm/W	115°	0,72W
M3AZ	■	463-475nm	IP 65	12V DC	9,6lm	13,3lm/W	115°	0,72W
M3V	■	584-594nm	IP 65	12V DC	36lm	50lm/W	115°	0,72W
M3BF	■	6000°K	IP 65	12V DC	48lm	66,7lm/W	115°	0,72W
M3BC	■	3000°K	IP 65	12V DC	48lm	66,7lm/W	115°	0,72W

Fuente de alimentación recomendada para 20 Pcs LPV2012 / Recommended power supply for 20 Pcs LVP2012



27 /

MÓDULO 3 LEDS RGB

3 LEDS MODULES RGB

Módulos de 3 LEDs tipo 5050 ideales para rotulación y letras corpóreas. Se entregan cableados en kits de 20 piezas. Se fijan mediante cinta adhesiva o tornillos. Ideales para letras corpóreas o cajas de luz con un fondo de 6 a 16cm. Se pueden unir en serie un máximo de 50 Pcs.

Modules 3 LEDs 5050 for neon signs. Wire kits of 20 pieces included. The strip can be fixed with adhesive or screws. Ideal for neon signs or lighting boxes of 6 to 16 cm deep. Until 50 Pcs can be connected in serie.

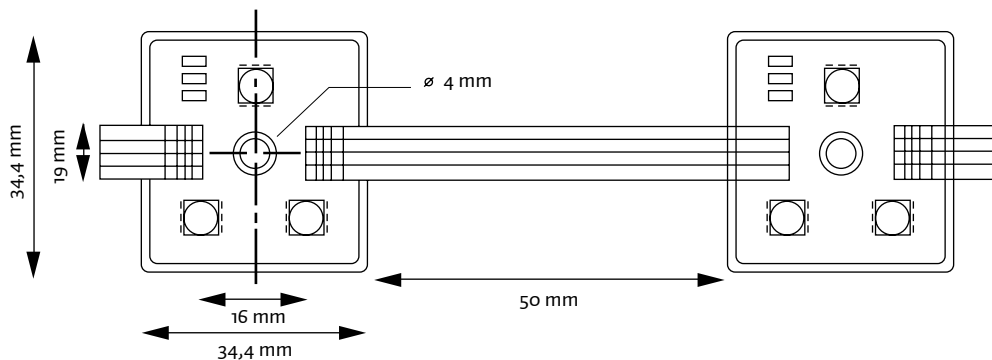

REFERENCIA REFERENCE	COLOR COLOR	TEMPERATURA TEMPERATURE	PROTECCIÓN PROTECTION	ALIMENTACIÓN POWER SUPPLY	FLUJO LUM. LUM. FLOW	ÁNGULO ANGLE	CONSUMO CONSUME
	█	620-630nm	IP 65	12V DC	10,5lm	115°	0,48W
M3RGB	█	584-594 nm	IP 65	12V DC	18,0lm	115°	0,48W
	█	463-475nm	IP 65	12V DC	10,5lm	115°	0,48W

Fuente de alimentación recomendada para 20Pcs LPV2012. Es necesario un controlador RGB para el funcionamiento de los módulos / Recommended power supply for 20Pcs: LPV2012. It is necessary to use a RGB controller



28 /

MÓDULO 4 LEDS

4 LEDS MODULES

Módulos de 4 LEDS tipo 5050 ideales para rotulación y letras corpóreas. Se entregan cableados en kits de 20 piezas. Se fijan mediante cinta adhesiva o tornillos. Ideales para letras corpóreas o cajas de luz con un fondo de 6 a 18cm. Se pueden unir en serie un máximo de 20 Pcs.

Modules 4 LEDS 5050 for neon signs. Wire kits of 20 pieces included. The strip can be fixed with adhesive or screws. Ideal for neon signs or lighting boxes of 6 to 18 cm deep. Until 20 Pcs can be connected in serie.

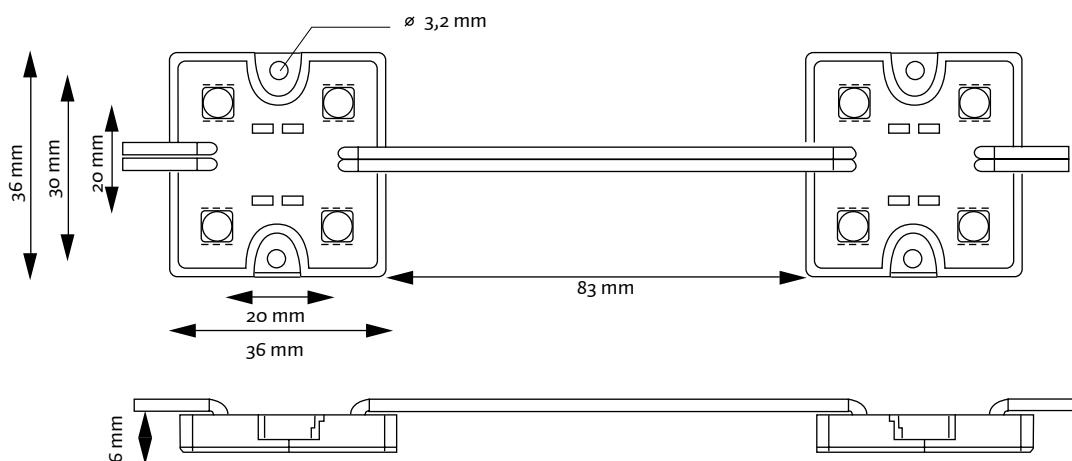

REFERENCIA	COLOR	TEMPERATURA	PROTECCIÓN	ALIMENTACIÓN	FLUJO LUM.	EFICIENCIA L.	ÁNGULO	CONSUMO
REFERENCE	COLOR	TEMPERATURE	PROTECTION	POWER SUPPLY	LUM. FLOW	EFFICIENCY	ANGLE	CONSUME
M4R		620-630nm	IP 65	12V DC	24,4lm	25,4lm/W	115°	0,96W
M4AM		512-528nm	IP 65	12V DC	19,20lm	20lm/W	115°	0,96W
M4AZ		463-475nm	IP 65	12V DC	12,8lm	13,3lm/W	115°	0,96W
M4V		584-594nm	IP 65	12V DC	48lm	50lm/W	115°	0,96W
M4BF		6000°K	IP 65	12V DC	64lm	66,7lm/W	115°	0,96W
M4BC		3000°K	IP 65	12V DC	64lm	66,7lm/W	115°	0,96W

Fuente de alimentación recomendada para 20Pcs LPV3512 / Recommended power supply for 20Pcs: LPV3512

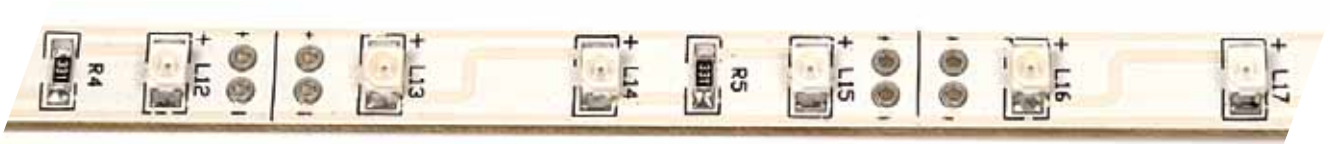

29 /

TIRA RÍGIDA DE 30 LEDS SMD 30 LEDS SMD RIGID STRIP

Tira rígida de 480 mm (574 mm RGB) de longitud x 8 mm (10 mm RGB) de ancho con 30 LEDS SMD de diferentes colores o RGB. Se puede cortar cada 3 LEDS (46 mm). Se suministra con cable de conexión y accesorios de montaje.

Rigid strip 480 mm length (574 mm RGB) x 8 mm (10 mm RGB) wide with 30 LEDS SMD in different colours or RGB. It can be cut each 3 LEDS (46 mm). It's supplied with connection wire and mounting accessories.

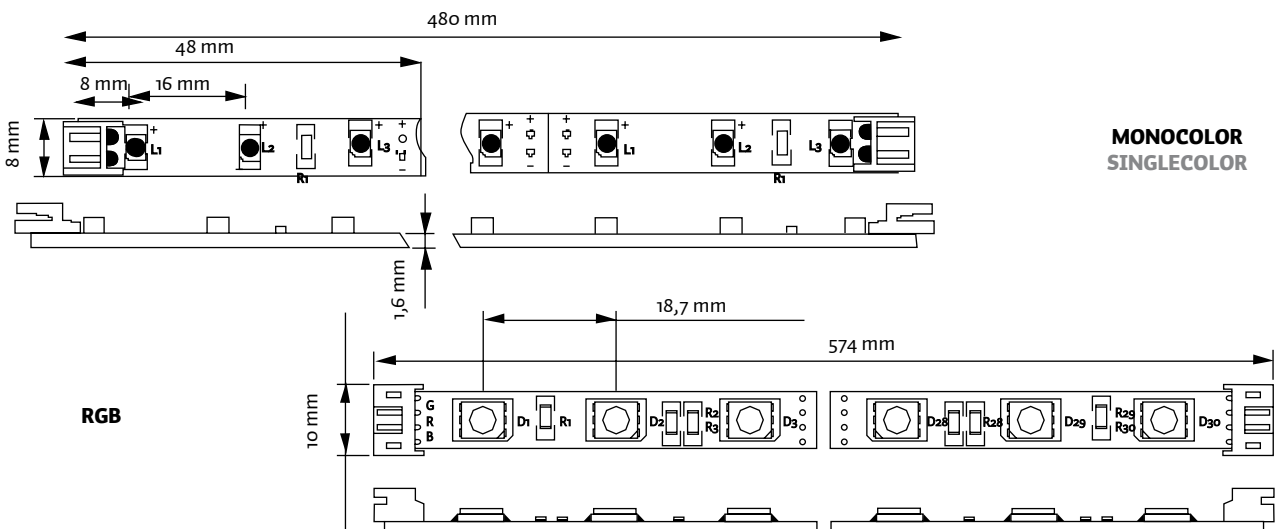

REFERENCIA REFERENCE	COLOR COLOR	PROTECCIÓN PROTECTION	ALIMENTACIÓN POWER SUPPLY	TIPO LED LED TYPE	CANT. 1/2 mts Qty OF LED	FLUJO LUM. LUM. FLOW	CONSUMO CONSUME
TR30R	Red	IP 33	12V DC	3528	30 LEDS/0,5 mts	27lm	2,4W
TR30AB	Yellow	IP 33	12V DC	3528	30 LEDS/0,5 mts	27lm	2,4W
TR30AZ	Blue	IP 33	12V DC	3528	30 LEDS/0,5 mts	18lm	2,4W
TR30V	Green	IP 33	12V DC	3528	30 LEDS/0,5 mts	48lm	2,4W
TR30BF	White	IP 33	12V DC	3528	30 LEDS/0,5 mts	53lm	2,4W
TR30BC	Yellow	IP 33	12V DC	3528	30 LEDS/0,5 mts	48lm	2,4W
TR30RGB	RGB	IP 33	12V DC	3528	30 LEDS/0,5 mts	270-480-180lm	7,2W

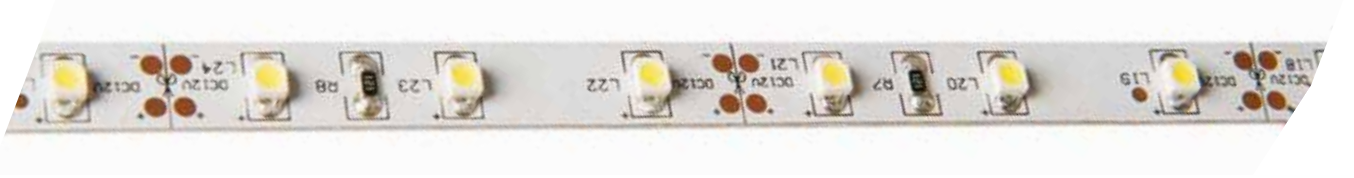

30 /

TIRA FLEXIBLE MONOCOLOR 300 LEDS 3528 IP33 SINGLE-COLOR FLEXIBLE STRIPS 300 LEDS 3528 IP33

Roll of flexible strip of 5 mts monocolour 300 LEDS SMD 3528. Se puede cortar cada 3 LEDS (50mm). Se suministra con adhesivo 3M de doble cara. Protección IP33.

5 mts Flexible strip roll single-color with 300 LEDS SMD 3528. Can be cut every 3 LEDS (50mm). Provided with 3M double side adhesive. IP33 protection.

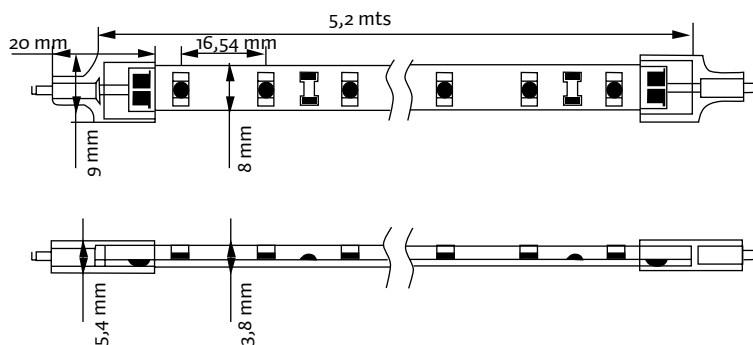

REFERENCIA REFERENCE	COLOR COLOR	PROTECCIÓN PROTECTION	ALIMENTACIÓN POWER SUPPLY	TIPO LED LED TYPE	CANT. mts Qty OF LED	FLUJO LUM. LUM. FLOW	CONSUMO CONSUME
TF5R	█	IP 33	12V DC	3528	60 LEDS/ mts	600lm	4,8W/ mts
TF5AB	█	IP 33	12V DC	3528	60 LEDS/ mts	600lm	4,8W/ mts
TF5AZ	█	IP 33	12V DC	3528	60 LEDS/ mts	750lm	4,8W/ mts
TF5V	█	IP 33	12V DC	3528	60 LEDS/ mts	1200lm	4,8W/ mts
TF5BF	█	IP 33	12V DC	3528	60 LEDS/ mts	1950lm	4,8W/ mts
TF5BC	█	IP 33	12V DC	3528	60 LEDS/ mts	1800lm	4,8W/ mts

Fuente de alimentación recomendada para un rollo de 5 mts FT123 (12V 40W) / Recommended power supply for a 5 mts roll: FT123 (12V 40W)



31 /

TIRA FLEXIBLE MONOCOLOR 300 LEDS 3528 IP66 SINGLE-COLOR FLEXIBLE STRIPS 300 LEDS IP66

Rollo de tira flexible de 5 mts monocolor 300 LEDS SMD 3528. Se puede cortar cada 3 LEDS (50 mm). Se suministra con adhesivo 3M de doble cara. Protección IP66
5 mts Flexible strip roll single-color with 300 LEDS SMD 3528. Can be cut every 3 LEDS (50 mm). Provided with 3M double side adhesive. IP66 protection

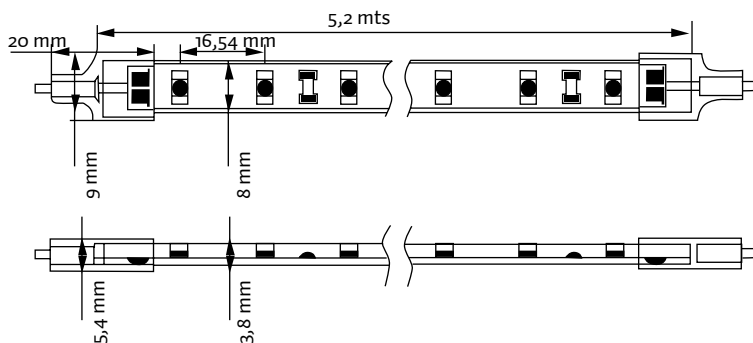

REFERENCIA REFERENCE	COLOR COLOR	PROTECCIÓN PROTECTION	ALIMENTACIÓN POWER SUPPLY	TIPO LED LED TYPE	CANT. mts Qty OF LED	FLUJO LUM. LUM. FLOW	CONSUMO CONSUME
TF5RIP66		IP 66	12V DC	3528	60 LEDS/ mts	600lm	4,8W/mts
TF5ABIP66		IP 66	12V DC	3528	60 LEDS/ mts	600lm	4,8W/mts
TF5AZIP66		IP 66	12V DC	3528	60 LEDS/ mts	750lm	4,8W/mts
TF5VIP66		IP 66	12V DC	3528	60 LEDS/ mts	1200lm	4,8W/mts
TF5BFIP66		IP 66	12V DC	3528	60 LEDS/ mts	1950lm	4,8W/mts
TF5BCIP66		IP 66	12V DC	3528	60 LEDS/ mts	1800lm	4,8W/mts

Fuente de alimentación recomendada para un rollo de 5 mts FT123 (12V 40W) / Recommended power supply for a 5 mts roll: FT123 (12V 40W)



32 /

TIRA FLEXIBLE MONOCOLOR 300 LEDS 3528 IP68 SINGLE-COLOR FLEXIBLE STRIPS 300 LEDS 3528 IP68

Rollo de tira flexible de 5 mts monocolor 300 LEDS SMD 3528. Se puede cortar cada 3 LEDS (50 mm). Se suministra con adhesivo 3M de doble cara. Protección IP68.

5 mts Flexible strip roll single-color with 300 LEDS SMD 3528. Can be cut every 3 LEDS (50 mm). Provided with 3M double side adhesive. IP68 protection.

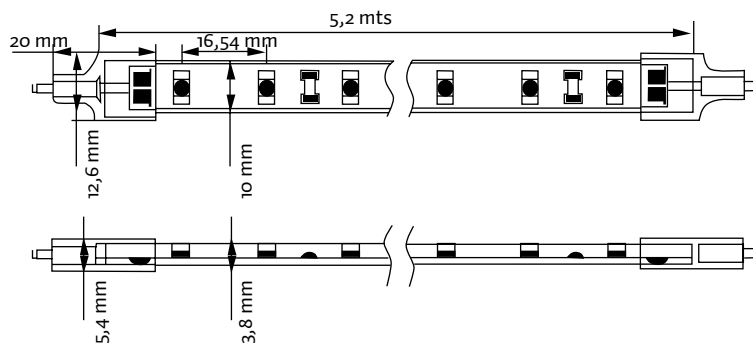

REFERENCIA REFERENCE	COLOR COLOR	PROTECCIÓN PROTECTION	ALIMENTACIÓN POWER SUPPLY	TIPO LED LED TYPE	CANT. mts Qty OF LED	FLUJO LUM. LUM. FLOW	CONSUMO CONSUME
TF5RIP68	■	IP 68	12V DC	3528	60 LEDS/ mts	600lm	4,8W/ mts
TF5ABIP68	■	IP 68	12V DC	3528	60 LEDS/ mts	600lm	4,8W/ mts
TF5AZIP68	■	IP 68	12V DC	3528	60 LEDS/ mts	750lm	4,8W/ mts
TF5VIP68	■	IP 68	12V DC	3528	60 LEDS/ mts	1200lm	4,8W/ mts
TF5BFIP68	■	IP 68	12V DC	3528	60 LEDS/ mts	1950lm	4,8W/ mts
TF5BCIP68	■	IP 68	12V DC	3528	60 LEDS/ mts	1800lm	4,8W/ mts

Fuente de alimentación recomendada para un rollo de 5 mts LPV3512 (12V 35W) / Recommended power supply for a 5 mts roll: LPV3512 (12V 35W)



33 /

TIRA FLEXIBLE MONOCOLOR 300 LEDS 3528 IP33 ASIMÉTRICA 90° SINGLE-COLOR FLEXIBLE STRIPS 300 LEDS IP33 ASYMETRIC 90°

Rollo de tira flexible de 5 mts monocolor 300 LEDs SMD 3528. Se puede cortar cada 3 LEDs (50 mm). Se suministra con adhesivo 3M de doble cara. Protección IP33. LEDs inclinados 90° para generar un haz de luz asimétrico.

5 mts Flexible strip roll single-color with 300 LEDs SMD 3528. Can be cut every 3 LEDs (50 mm). Provided with 3M double side adhesive. IP33 protection. Asymetric light 90°.

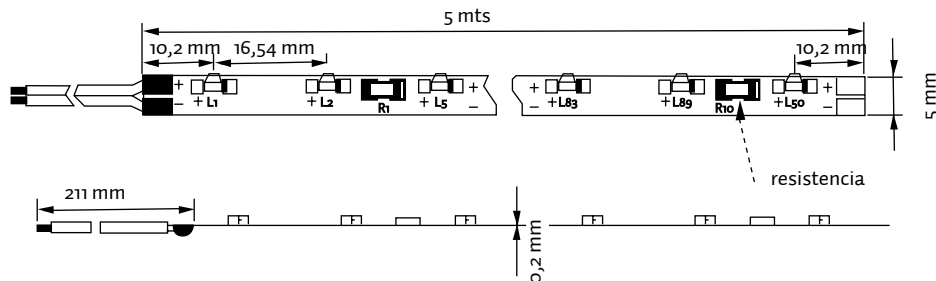

REFERENCIA REFERENCE	COLOR COLOR	PROTECCIÓN PROTECTION	ALIMENTACIÓN POWER SUPPLY	TIPO LED LED TYPE	CANT. mts Qty of LED	FLUJO LUM. LUM. FLOW	CONSUMO CONSUME
TF5R90		IP 33	12V DC	3528	60 LEDs/ mts	600lm	4,8W/ mts
TF5AB90		IP 33	12V DC	3528	60 LEDs/ mts	600lm	4,8W/ mts
TF5AZ90		IP 33	12V DC	3528	60 LEDs/ mts	750lm	4,8W/ mts
TF5V90		IP 33	12V DC	3528	60 LEDs/ mts	1200lm	4,8W/ mts
TF5BF90		IP 33	12V DC	3528	60 LEDs/ mts	1950lm	4,8W/ mts
TF5BC90		IP 33	12V DC	3528	60 LEDs/ mts	1800lm	4,8W/ mts

Fuente de alimentación recomendada para un rollo de 5 mts FT123 (12V 40W) / Recommended power supply for a 5 mts roll: FT123 (12V 40W)



34 /

TIRA FLEXIBLE MONOCOLOR 300 LEDS 3528 IP66 ASIMÉTRICA 90° SINGLE-COLOR FLEXIBLE STRIPS 300 LEDS IP66 ASYMMETRIC 90°

Rollo de tira flexible de 5 mts monocolor 300 LEDS SMD 3528. Se puede cortar cada 3 LEDS (50mm). Se suministra con adhesivo 3M de doble cara. Protección IP66. LEDS inclinados 90° para generar un haz de luz asimétrico.

5 mts flexible strip roll single-color with 300 LEDS SMD 3528. Can be cut every 3 LEDS (50mm). Provided with 3M double side adhesive. IP66 protection. Asymetric light 90°.

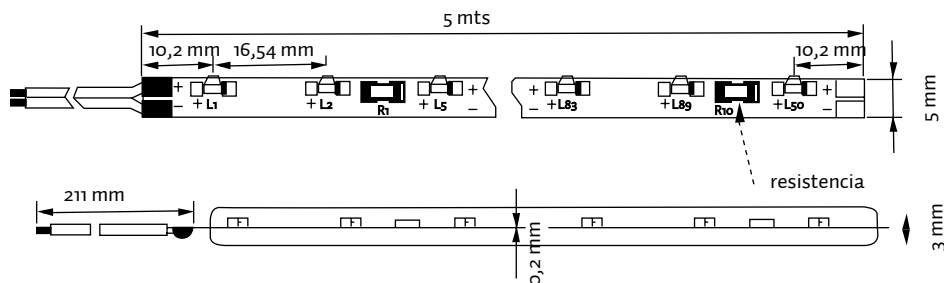

REFERENCIA REFERENCE	COLOR COLOR	PROTECCIÓN PROTECTION	ALIMENTACIÓN POWER SUPPLY	TIPO LED LED TYPE	CANT. mts Qty OF LED	FLUJO LUM. LUM. FLOW	CONSUMO CONSUME
TF5R90-IP66	Red	IP 66	12V DC	3528	60 LEDS/ mts	600lm	4,8W/ mts
TF5AB90-IP66	Yellow	IP 66	12V DC	3528	60 LEDS/ mts	600lm	4,8W/ mts
TF5AZ90-IP66	Blue	IP 66	12V DC	3528	60 LEDS/ mts	750lm	4,8W/ mts
TF5V90-IP66	Green	IP 66	12V DC	3528	60 LEDS/ mts	1200lm	4,8W/ mts
TF5BF90-IP66	White	IP 66	12V DC	3528	60 LEDS/ mts	1950lm	4,8W/ mts
TF5BC90-IP66	Yellow	IP 66	12V DC	3528	60 LEDS/ mts	1800lm	4,8W/ mts

Fuente de alimentación recomendada para un rollo de 5 mts FT123 (12V 40W) / Recommended power supply for a 5 mts roll: FT123 (12V 40W)



35 /

TIRAS FLEXIBLES MONOCOLOR 600 LEDS 3528 IP33 SINGLE-COLOR FLEXIBLE STRIPS 600 LEDS 3528 IP33

Rollo de tira flexible de 5 mts monocolor 600 LEDS SMD 3528. Se puede cortar cada 6 LEDS (50mm).
Se suministra con adhesivo 3M de doble cara. Protección IP33.

5 mts Flexible strip roll single-color with 600 LEDS SMD 3528. Can be cut every 6 LEDS (50mm).
Provided with 3M double side adhesive. IP33 protection.

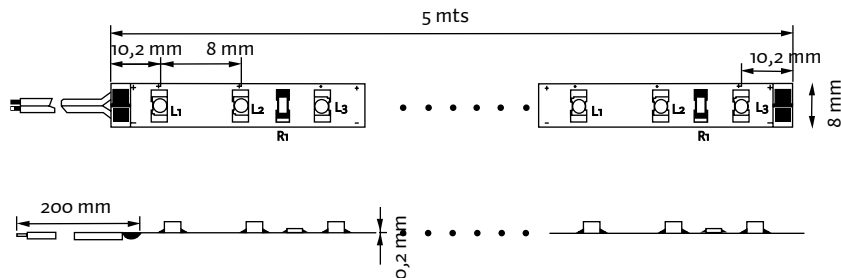

REFERENCIA REFERENCE	COLOR COLOR	PROTECCIÓN PROTECTION	ALIMENTACIÓN POWER SUPPLY	TIPO LED LED TYPE	CANT. mts Qty OF LED	FLUJO LUM. LUM. FLOW	CONSUMO CONSUME
TF5R-600		IP 33	24V DC	3528	120 LEDS/ mts	1200lm	9,6W/ mts
TF5AB-600		IP 33	24V DC	3528	120 LEDS/ mts	1200lm	9,6W/ mts
TF5AZ-600		IP 33	24V DC	3528	120 LEDS/ mts	1500lm	9,6W/ mts
TF5V-600		IP 33	24V DC	3528	120 LEDS/ mts	2400lm	9,6W/ mts
TF5BF-600		IP 33	24V DC	3528	120 LEDS/ mts	3900lm	9,6W/ mts
TF5BC-600		IP 33	24V DC	3528	120 LEDS/ mts	3600lm	9,6W/ mts

Fuente de alimentación recomendada para un rollo de 5 mts FT242 (24V 60W) / Recommended power supply for a 5 mts roll: FT242 (24V 60W)



36 /

TIRAS FLEXIBLES MONOCOLOR 600 LEDS 3528 IP66 SINGLE-COLOR FLEXIBLE STRIPS 600 LEDS 3528 IP66

Rollo de tira flexible de 5 mts monocolor 600 LEDS SMD 3528. Se puede cortar cada 6 LEDS (50mm).
Se suministra con adhesivo 3M de doble cara. Protección IP66.

5 mts Flexible strip roll single-color with 600 LEDS SMD 3528. Can be cut every 6 LEDS (50mm).
Provided with 3M double side adhesive. IP66 protection.

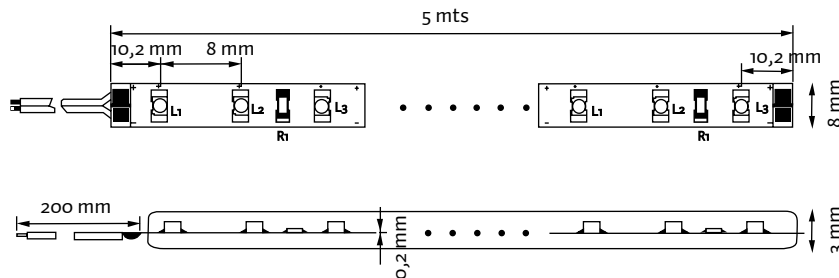

REFERENCIA REFERENCE	COLOR COLOR	PROTECCIÓN PROTECTION	ALIMENTACIÓN POWER SUPPLY	TIPO LED LED TYPE	CANT. mts Qty OF LED	FLUJO LUM. LUM. FLOW	CONSUMO CONSUME
TF5R-600-IP66		IP 66	24V DC	3528	120 LEDS/ mts	1200lm	9,6W/ mts
TF5AB-600-IP66		IP 66	24V DC	3528	120 LEDS/ mts	1200lm	9,6W/ mts
TF5AZ-600-IP66		IP 66	24V DC	3528	120 LEDS/ mts	1500lm	9,6W/ mts
TF5V-600-IP66		IP 66	24V DC	3528	120 LEDS/ mts	2400lm	9,6W/ mts
TF5BF-600-IP66		IP 66	24V DC	3528	120 LEDS/ mts	3900lm	9,6W/ mts
TF5BC-600-IP66		IP 66	24V DC	3528	120 LEDS/ mts	3600lm	9,6W/ mts

Fuente de alimentación recomendada para un rollo de 5 mts FT242 (24V 60W) / Recommended power supply for a 5 mts roll: FT242 (24V 60W)



37 /

TIRAS FLEXIBLES MONOCOLOR 600 LEDS 3528 IP68 SINGLE-COLOR FLEXIBLE STRIPS 600 LEDS 3528 IP68

Rollo de tira flexible de 5 mts monocolor 600 LEDS SMD 3528. Se puede cortar cada 6 LEDS (50mm).
Se suministra con adhesivo 3M de doble cara. Protección IP68.

5 mts Flexible strip roll single-color with 600 LEDS SMD 3528. Can be cut every 6 LEDS (50mm).
Provided with 3M double side adhesive. IP68 protection.

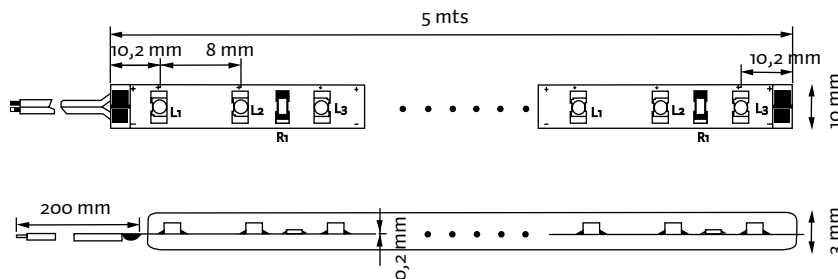

REFERENCIA REFERENCE	COLOR COLOR	PROTECCIÓN PROTECTION	ALIMENTACIÓN POWER SUPPLY	TIPO LED LED TYPE	CANT. mts Qty OF LED	FLUJO LUM. LUM. FLOW	CONSUMO CONSUME
TF5R-600-IP68		IP68	24V DC	3528	120 LEDS/ mts	1200lm	9,6W/ mts
TF5AB-600-IP68		IP68	24V DC	3528	120 LEDS/ mts	1200lm	9,6W/ mts
TF5AZ-600-IP68		IP68	24V DC	3528	120 LEDS/ mts	1500lm	9,6W/ mts
TF5V-600-IP68		IP68	24V DC	3528	120 LEDS/ mts	2400lm	9,6W/ mts
TF5BF-600-IP68		IP68	24V DC	3528	120 LEDS/ mts	3900lm	9,6W/ mts
TF5BC-600-IP68		IP68	24V DC	3528	120 LEDS/ mts	3600lm	9,6W/ mts

Fuente de alimentación recomendada para un rollo de 5 mts FT242 (24V 60W) / Recommended power supply for a 5 mts roll: FT242 (24V 60W)

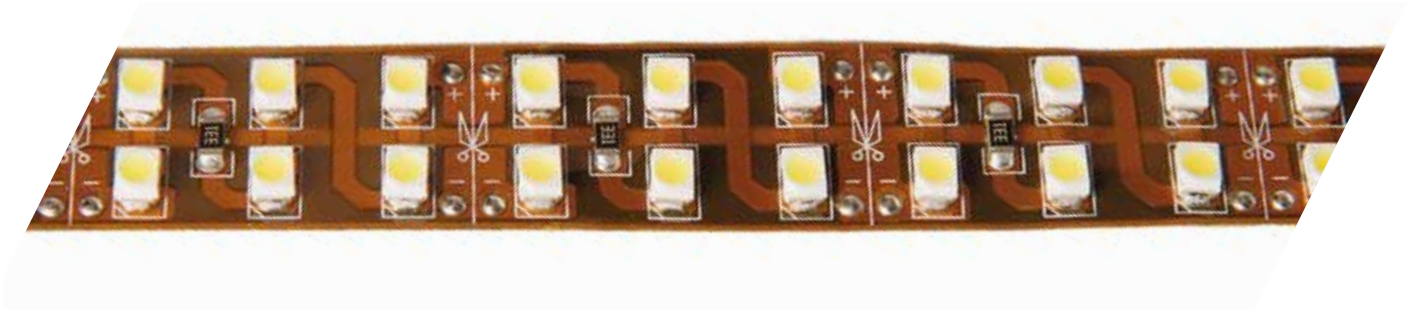

38 /

TIRAS FLEXIBLES MONOCOLOR 1200 LEDS 3528 IP33 SINGLE-COLOR FLEXIBLE STRIPS 1200 LEDS 3528 IP33

Rollo de tira flexible de 5 mts monocolor 1200 LEDS SMD 3528. Se puede cortar cada 12 LEDS (50mm).
Se suministra con adhesivo 3M de doble cara. Protección IP33.

5 mts Flexible strip roll single-color with 1200 LEDS SMD 3528. Can be cut every 12 LEDS (50mm).
Provided with 3M double side adhesive. IP33 protection.

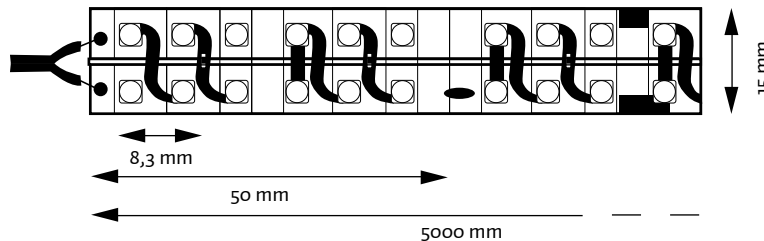

REFERENCIA REFERENCE	COLOR COLOR	PROTECCIÓN PROTECTION	ALIMENTACIÓN POWER SUPPLY	TIPO LED LED TYPE	CANT. mts Qty OF LED	FLUJO LUM. LUM. FLOW	CONSUMO CONSUME
TF5R-1200	Red	IP33	24V DC	3528	240 LEDS/ mts	2400lm	19,2W/ mts
TF5AB-1200	Yellow	IP33	24V DC	3528	240 LEDS/ mts	2400lm	19,2W/ mts
TF5AZ-1200	Blue	IP33	24V DC	3528	240 LEDS/ mts	3000lm	19,2W/ mts
TF5V-1200	Green	IP33	24V DC	3528	240 LEDS/ mts	2800lm	19,2W/ mts
TF5BF-1200	White	IP33	24V DC	3528	240 LEDS/ mts	7800lm	19,2W/ mts
TF5BC-1200	White	IP33	24V DC	3528	240 LEDS/ mts	7200lm	19,2W/ mts

Fuente de alimentación recomendada para un rollo de 5 mts RS15024 (24V 150W) / Recommended power supply for a 5 mts roll: RS15024 (24V 150W)

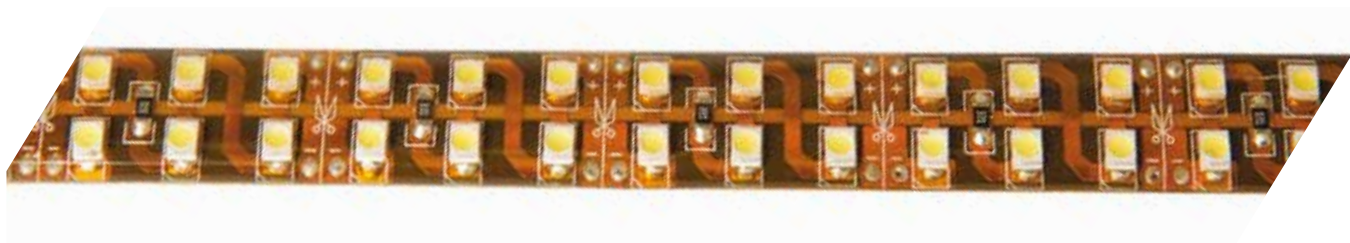

39 /

TIRAS FLEXIBLES MONOCOLOR 1200 LEDS 3528 IP66 SINGLE-COLOR FLEXIBLE STRIPS 1200 LEDS 3528 IP66

Rollo de tira flexible de 5 mts monocolor 1200 LEDS SMD 3528. Se puede cortar cada 12 LEDS (50mm). Se suministra con adhesivo 3M de doble cara. Protección IP66.

5 mts Flexible strip roll single-color with 1200 LEDS SMD 3528. Can be cut every 12 LEDS (50mm). Provided with 3M double side adhesive. IP66 protection.

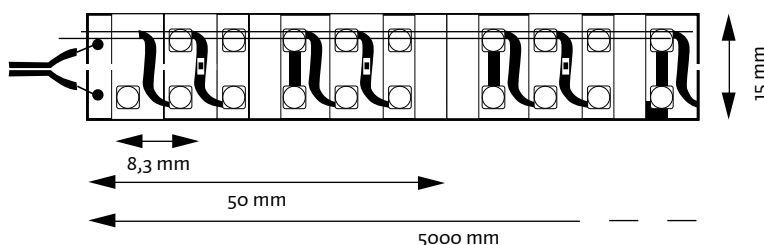

REFERENCIA REFERENCE	COLOR COLOR	PROTECCIÓN PROTECTION	ALIMENTACIÓN POWER SUPPLY	TIPO LED LED TYPE	CANT. mts Qty of LED	FLUJO LUM. LUM. FLOW	CONSUMO CONSUME
TF5R-1200-IP66	■	IP66	24V DC	3528	240 LEDS/ mts	2400lm	19,2W/ mts
TF5AB-1200-IP66	■	IP66	24V DC	3528	240 LEDS/ mts	2400lm	19,2W/ mts
TF5AZ-600-IP66	■	IP66	24V DC	3528	240 LEDS/ mts	3000lm	19,2W/ mts
TF5V-1200-IP66	■	IP66	24V DC	3528	240 LEDS/ mts	2800lm	19,2W/ mts
TF5BF-1200-IP66	■	IP66	24V DC	3528	240 LEDS/ mts	7800lm	19,2W/ mts
TF5BC-1200-IP66	■	IP66	24V DC	3528	240 LEDS/ mts	7200lm	19,2W/ mts

Fuente de alimentación recomendada para un rollo de 5 mts RS15024 (24V 150W) / Recommended power supply for a 5 mts roll: RS15024 (24V 150W)

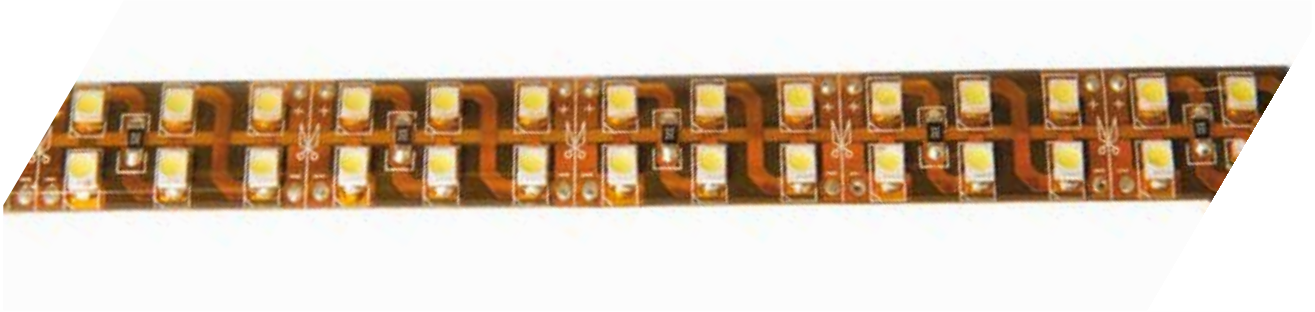

40 /

TIRAS FLEXIBLES MONOCOLOR 1200 LEDS 3528 IP68 SINGLE-COLOR FLEXIBLE STRIPS 1200 LEDS 3528 IP68

Rollo de tira flexible de 5 mts monocolor 1200 LEDS SMD 3528. Se puede cortar cada 12 LEDS (50mm). Se suministra con adhesivo 3M de doble cara. Protección IP68.

5 mts Flexible strip roll single-color with 1200 LEDS SMD 3528. Can be cut every 12 LEDS (50mm). Provided with 3M double side adhesive. IP66 protection..

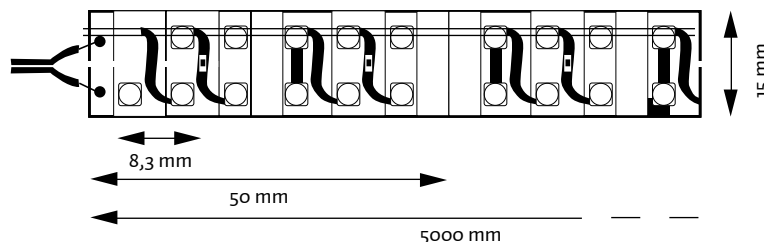

REFERENCIA REFERENCE	COLOR COLOR	PROTECCIÓN PROTECTION	ALIMENTACIÓN POWER SUPPLY	TIPO LED LED TYPE	CANT. mts Qty OF LED	FLUJO LUM. LUM. FLOW	CONSUMO CONSUME
TF5R-1200-IP68	■	IP68	24V DC	3528	240 LEDS/ mts	2400lm	19,2W/ mts
TF5AB-1200-IP68	■	IP68	24V DC	3528	240 LEDS/ mts	2400lm	19,2W/ mts
TF5AZ-1200-IP68	■	IP68	24V DC	3528	240 LEDS/ mts	3000lm	19,2W/ mts
TF5V-1200-IP68	■	IP68	24V DC	3528	240 LEDS/ mts	2800lm	19,2W/ mts
TF5BF-1200-IP68	■	IP68	24V DC	3528	240 LEDS/ mts	7800lm	19,2W/ mts
TF5BC-1200-IP68	■	IP68	24V DC	3528	240 LEDS/ mts	7200lm	19,2W/ mts

Fuente de alimentación recomendada para un rollo de 5 mts RS15024 (24V 150W) / Recommended power supply for a 5 mts roll: RS15024 (24V 150W)



41 /

TIRAS FLEXIBLES MONOCOLOR O RGB 150 LEDS 5050 IP33

RGB OR SINGLE-COLOR FLEXIBLE STRIPS 150 LEDS 5050 IP33

Rollo de tira flexible de 5 mts monocolor o RGB con 150 LEDS SMD 5050. Se puede cortar cada 3 LEDS (100mm). Se suministra con adhesivo 3M de doble cara. Protección IP33. 36W de consumo total el rollo de 5 mts.
 5 mts Flexible strip roll single-color or RGB with 150 LEDS SMD 5050. Can be cut every 3 LEDS (100mm). Provided with 3M double side adhesive. IP33 protection. 5 mts roll total consume is 36W.

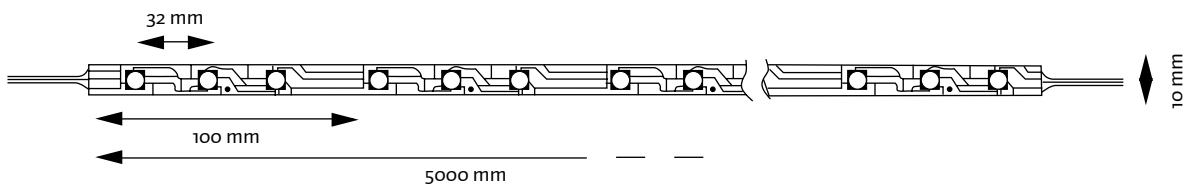

REFERENCIA REFERENCE	COLOR COLOR	PROTECCIÓN PROTECTION	ALIMENTACIÓN POWER SUPPLY	TIPO LED LED TYPE	CANT. mts Qty OF LED	FLUJO LUM. LUM. FLOW	CONSUMO CONSUME
TF5R-AP		IP33	12V DC	5050	150 LEDS/ mts	900lm	7,2W/ mts
TF5AB-AP		IP33	12V DC	5050	150 LEDS/ mts	900lm	7,2W/ mts
TF5AZ-AP		IP33	12V DC	5050	150 LEDS/ mts	1125lm	7,2W/ mts
TF5V-AP		IP33	12V DC	5050	150 LEDS/ mts	1800lm	7,2W/ mts
TF5BF-AP		IP33	12V DC	5050	150 LEDS/ mts	2925lm	7,2W/ mts
TF5BC-AP		IP33	12V DC	5050	150 LEDS/ mts	2700lm	7,2W/ mts
TF5RGB		IP33	12V DC	5050	150 LEDS/ mts	300-600-375lm	7,2W/ mts

Fuente de alimentación recomendada para un rollo de 5 mts FT125 (12V 60W). Para la tira RGB escoger también un controlador CVRRGB / Recomendad power supply for a 5 mts roll: FT125 (12V 60W). For RGB strip also opt for a controller CVRRGB



42 /

TIRAS FLEXIBLES MONOCOLOR O RGB 150 LEDS 5050 IP66

RGB OR SINGLE-COLOR FLEXIBLE STRIPS 150 LEDS 5050 IP66

Rollo de tira flexible de 5 mts monocolor o RGB con 150 LEDS SMD 5050. Se puede cortar cada 3 LEDS (100mm). Se suministra con adhesivo 3M de doble cara. Protección IP66. 36W de consumo total el rollo de 5 mts.

5 mts Flexible strip roll single-color or RGB with 150 LEDS SMD 5050. Can be cut every 3 LEDS (100mm). Provided with 3M double side adhesive. IP66 protection. 5 mts roll total consume is 36W.

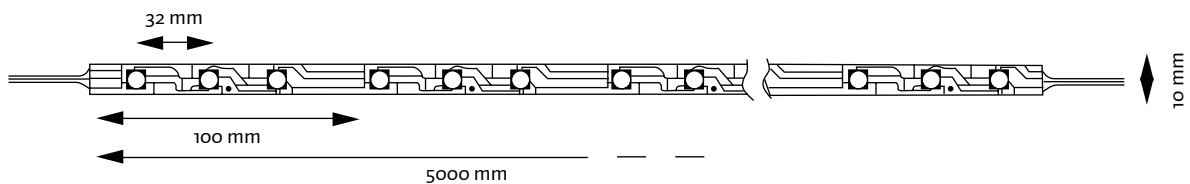

REFERENCIA REFERENCE	COLOR COLOR	PROTECCIÓN PROTECTION	ALIMENTACIÓN POWER SUPPLY	TIPO LED LED TYPE	CANT. mts Qty OF LED	FLUJO LUM. LUM. FLOW	CONSUMO CONSUME
TF5R-AP-166	Red	IP66	12V DC	5050	150 LEDS/ mts	900lm	7,2W/ mts
TF5AB-AP-166	Yellow	IP66	12V DC	5050	150 LEDS/ mts	900lm	7,2W/ mts
TF5AZ-AP-166	Blue	IP66	12V DC	5050	150 LEDS/ mts	1125lm	7,2W/ mts
TF5V-AP-166	Green	IP66	12V DC	5050	150 LEDS/ mts	1800lm	7,2W/ mts
TF5BF-AP-166	White	IP66	12V DC	5050	150 LEDS/ mts	2925lm	7,2W/ mts
TF5BC-AP-166	White	IP66	12V DC	5050	150 LEDS/ mts	2700lm	7,2W/ mts
TF5RGB-166	RGB	IP66	12V DC	5050	150 LEDS/ mts	300-600-375lm	7,2W/ mts

Fuente de alimentación recomendada para un rollo de 5 mts FT125 (12V 60W). Para la tira RGB escoger también un controlador CVRRGB / Recomendad power supply for a 5 mts roll: FT125 (12V 60W). For RGB strip also opt for a controller CVRRGB



43 /

TIRAS FLEXIBLES MONOCOLOR O RGB 150 LEDS 5050 IP68

RGB OR SINGLE-COLOR FLEXIBLE STRIPS 150 LEDS 5050 IP68

Rollo de tira flexible de 5 mts monocolor o RGB con 150 LEDS SMD 5050. Se puede cortar cada 3 LEDS (100mm). Se suministra con adhesivo 3M de doble cara. Protección IP68. 36W de consumo total el rollo de 5 mts.

5 mts Flexible strip roll single-color or RGB with 150 LEDS SMD 5050. Can be cut every 3 LEDS (100mm). Provided with 3M double side adhesive. IP68 protection. 5 mts roll total consume is 36W.

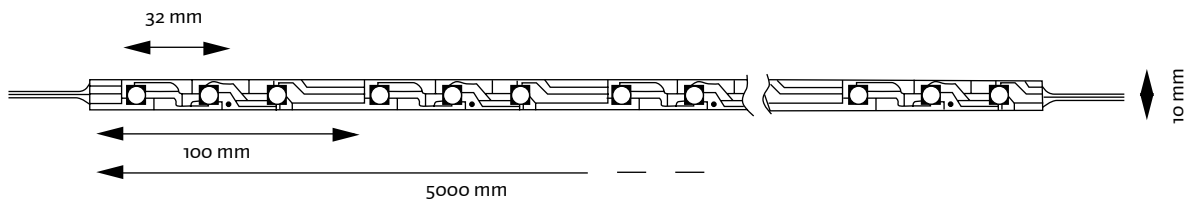

REFERENCIA REFERENCE	COLOR COLOR	PROTECCIÓN PROTECTION	ALIMENTACIÓN POWER SUPPLY	TIPO LED LED TYPE	CANT. mts Qty OF LED	FLUJO LUM. LUM. FLOW	CONSUMO CONSUME
TF5R-AP-IP68	■	IP68	12V DC	5050	150 LEDS/ mts	900lm	7,2W/ mts
TF5AB-AP-IP68	■	IP68	12V DC	5050	150 LEDS/ mts	900lm	7,2W/ mts
TF5AZ-AP-IP68	■	IP68	12V DC	5050	150 LEDS/ mts	1125lm	7,2W/ mts
TF5V-AP-IP68	■	IP68	12V DC	5050	150 LEDS/ mts	1800lm	7,2W/ mts
TF5BF-AP-IP68	■	IP68	12V DC	5050	150 LEDS/ mts	2925lm	7,2W/ mts
TF5BC-AP-IP68	■	IP68	12V DC	5050	150 LEDS/ mts	2700lm	7,2W/ mts
TF5RGB-IP68	■ ■ ■	IP68	12V DC	5050	150 LEDS/ mts	300-600-375lm	7,2W/ mts

Fuente de alimentación recomendada para un rollo de 5 mts LPV6012 (12V 60W). Para la tira RGB escoger también un controlador CVRRGB
 Recommended power supply for a 5 mts roll: LPV6012 (12V 60W). For RGB strip also opt for a controller CVRRGB

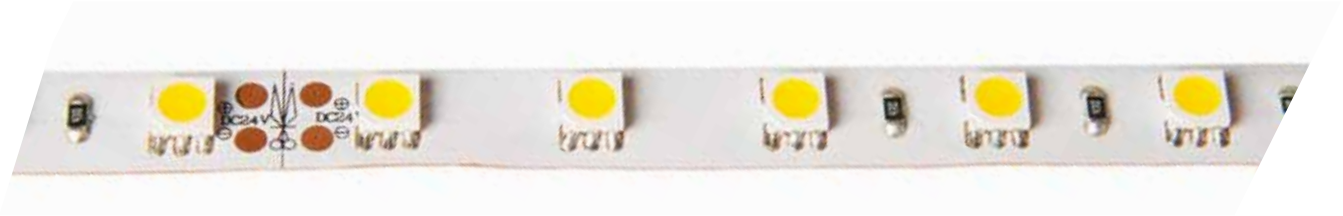

44 /

TIRAS FLEXIBLES MONOCOLOR O RGB 300 LEDS 5050 IP33

RGB OR SINGLE-COLOR FLEXIBLE STRIPS 300 LEDS 5050 IP33

Rollo de tira flexible de 5 mts monocolor o RGB con 300 LEDS SMD 5050. Se puede cortar cada 6 LEDS (100mm). Se suministra con adhesivo 3M de doble cara. Protección IP33. 72W de consumo total el rollo de 5 mts.

5 mts Flexible strip roll single-color or RGB with 300 LEDS SMD 5050. Can be cut every 3 LEDs (100mm). Provided with 3M double side adhesive. IP33 protection. 5 mts roll total consume is 72W.

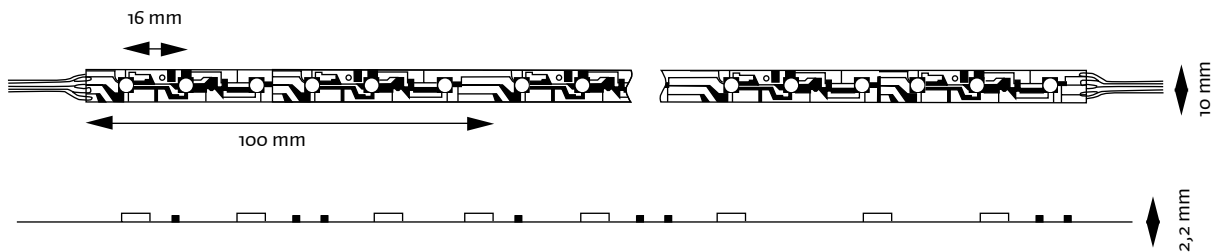

REFERENCIA REFERENCE	COLOR COLOR	PROTECCIÓN PROTECTION	ALIMENTACIÓN POWER SUPPLY	TIPO LED LED TYPE	CANT. mts Qty OF LED	FLUJO LUM. LUM. FLOW	CONSUMO CONSUME
TF5R-AP-300	Red	IP33	24V DC	5050	300 LEDS/ mts	1800lm	14,4W/ mts
TF5AB-AP-300	Yellow	IP33	24V DC	5050	300 LEDS/ mts	1800lm	14,4W/ mts
TF5AZ-AP-300	Blue	IP33	24V DC	5050	300 LEDS/ mts	2250lm	14,4W/ mts
TF5V-AP-300	Green	IP33	24V DC	5050	300 LEDS/ mts	3600lm	14,4W/ mts
TF5BF-AP-300	White	IP33	24V DC	5050	300 LEDS/ mts	5850lm	14,4W/ mts
TF5BC-AP-300	White	IP33	24V DC	5050	300 LEDS/ mts	5400lm	14,4W/ mts
TF5RGB-300	RGB	IP33	24V DC	5050	300 LEDS/ mts	600-1K2-750lm	14,4W/ mts

Fuente de alimentación recomendada para un rollo de 5 mts FT244 o RS10024 (24V 100W). Para la tira RGB escoger también un controlador CVRRGB
 Recommended power supply for a 5 mts roll: FT244 o RS10024 (24V 100W). For RGB strip also opt for a controller CVRRGB



45 /

TIRAS FLEXIBLES MONOCOLOR O RGB 300 LEDS 5050 IP66

RGB OR SINGLE-COLOR FLEXIBLE STRIPS 300 LEDS 5050 IP66

Rollo de tira flexible de 5 mts monocolor o RGB con 300 LEDS SMD 5050. Se puede cortar cada 6 LEDS (100mm). Se suministra con adhesivo 3M de doble cara. Protección IP66. 72W de consumo total el rollo de 5 mts.

5 mts Flexible strip roll single-color or RGB with 300 LEDS SMD 5050. Can be cut every 3 LEDs (100mm). Provided with 3M double side adhesive. IP366 protection. 5 mts roll total consume is 72W.

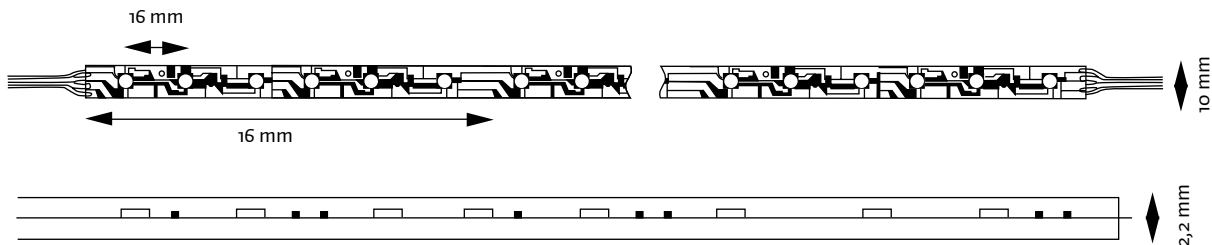

REFERENCIA REFERENCE	COLOR COLOR	PROTECCIÓN PROTECTION	ALIMENTACIÓN POWER SUPPLY	TIPO LED LED TYPE	CANT. mts Qty OF LED	FLUJO LUM. LUM. FLOW	CONSUMO CONSUME
TF5R-AP-300-IP66		IP66	24V DC	5050	300 LEDS/ mts	1800lm	14,4W/ mts
TF5AB-AP-300-IP66		IP66	24V DC	5050	300 LEDS/ mts	1800lm	14,4W/ mts
TF5AZ-AP-300-IP66		IP66	24V DC	5050	300 LEDS/ mts	2250lm	14,4W/ mts
TF5V-AP-300-IP66		IP66	24V DC	5050	300 LEDS/ mts	3600lm	14,4W/ mts
TF5BF-AP-300-IP66		IP66	24V DC	5050	300 LEDS/ mts	5850lm	14,4W/ mts
TF5BC-AP-300-IP66		IP66	24V DC	5050	300 LEDS/ mts	5400lm	14,4W/ mts
TF5RGB-300-IP66		IP66	24V DC	5050	300 LEDS/ mts	600-1K2-750lm	14,4W/ mts

Fuente de alimentación recomendada para un rollo de 5 mts FT244 o RS10024 (24V 100W). Para la tira RGB escoger también un controlador CVRRGB
 Recommended power supply for a 5 mts roll: FT244 o RS10024 (24V 100W). For RGB strip also opt for a controller CVRRGB

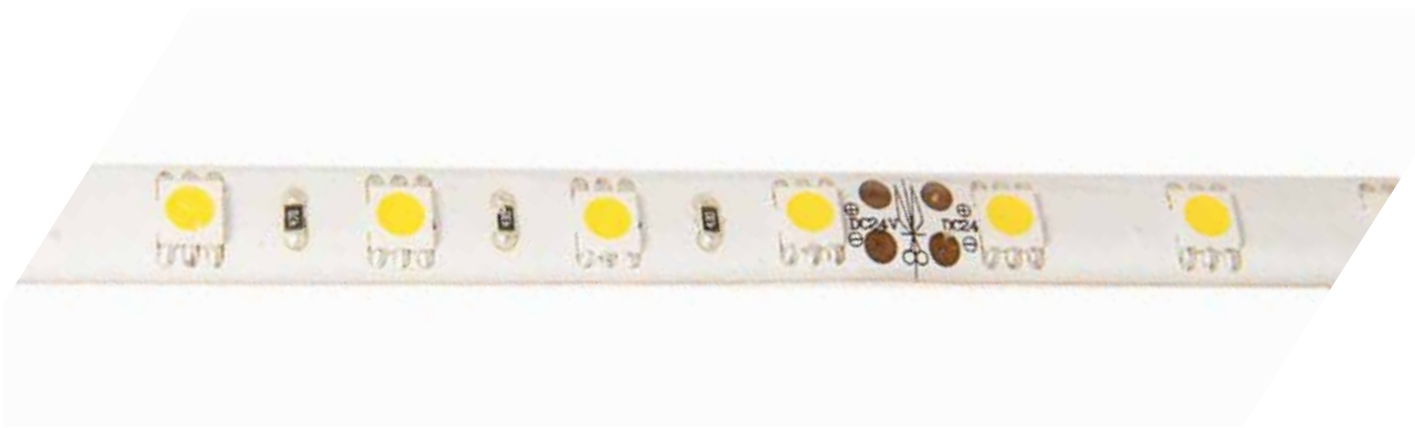

46 /

TIRAS FLEXIBLES MONOCOLOR O RGB 300 LEDS 5050 IP68

RGB OR SINGLE-COLOR FLEXIBLE STRIPS 300 LEDS 5050 IP68

Rollo de tira flexible de 5 mts monocolor o RGB con 300 LEDS SMD 5050. Se puede cortar cada 6 LEDS (100mm). Se suministra con adhesivo 3M de doble cara. Protección IP68. 72W de consumo total el rollo de 5 mts.

5 mts Flexible strip roll single-color or RGB with 300 LEDS SMD 5050. Can be cut every 6 LEDS (100mm). Provided with 3M double side adhesive. IP68 protection. Total consume of the 5 mts roll: 72W.

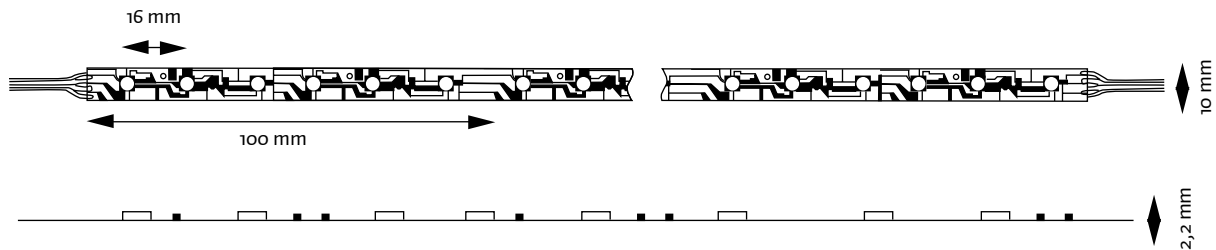

REFERENCIA REFERENCE	COLOR COLOR	PROTECCIÓN PROTECTION	ALIMENTACIÓN POWER SUPPLY	TIPO LED LED TYPE	CANT. mts Qty OF LED	FLUJO LUM. LUM. FLOW	CONSUMO CONSUME
TF5R-AP-300-IP68		IP68	24V DC	5050	300 LEDS/ mts	1800lm	14,4W/ mts
TF5AB-AP-300-IP68		IP68	24V DC	5050	300 LEDS/ mts	1800lm	14,4W/ mts
TF5AZ-AP-300-IP68		IP68	24V DC	5050	300 LEDS/ mts	2250lm	14,4W/ mts
TF5V-AP-300-IP68		IP68	24V DC	5050	300 LEDS/ mts	3600lm	14,4W/ mts
TF5BF-AP-300-IP68		IP68	24V DC	5050	300 LEDS/ mts	5850lm	14,4W/ mts
TF5BC-AP-300-IP68		IP68	24V DC	5050	300 LEDS/ mts	5400lm	14,4W/ mts
TF5RGB-300-IP68		IP68	24V DC	5050	300 LEDS/ mts	600-1K2-750lm	14,4W/ mts

Fuente de alimentación recomendada para un rollo de 5 mts LPV10024 (24V 100W). Para la tira RGB escoger también un controlador CVRRGB
 Recommended power supply for a 5 mts roll: LPV10024 (24V 100W). For RGB strip also opt for a controller CVRRGB



47 /

TIRAS FLEXIBLES DUAL 300 LEDs 5050 BLANCO FRÍO + BLANCO CÁLIDO DUAL FLEXIBLE STRIPS 300 LEDs 5050 COLD WHITE + WARM WHITE

Rollo de tira flexible de 5 mts DUAL con 300 LEDs SMD 5050. 150 LEDs en blanco frío y 150 LEDs en blanco cálido intercalados entre ellos. Posibilidad de generar cualquier tipo de blanco entre 2700 a 6500°K. Se puede cortar cada LED (15 mm). Se suministra con adhesivo 3M de doble cara. Protección IP33. 72W de consumo total el rollo de 5 mts.

5 mts flexible strip roll DUAL with 300 LED SMD 5050. 150 cold white and 150 warm white LEDs interleaved between them. Possibility to generate any kind of white between 2700 and 6500°. Can be cut every LED (15mm). Provided with 3M double side adhesive. IP33 protection. 5 mts roll total consume is 72W.

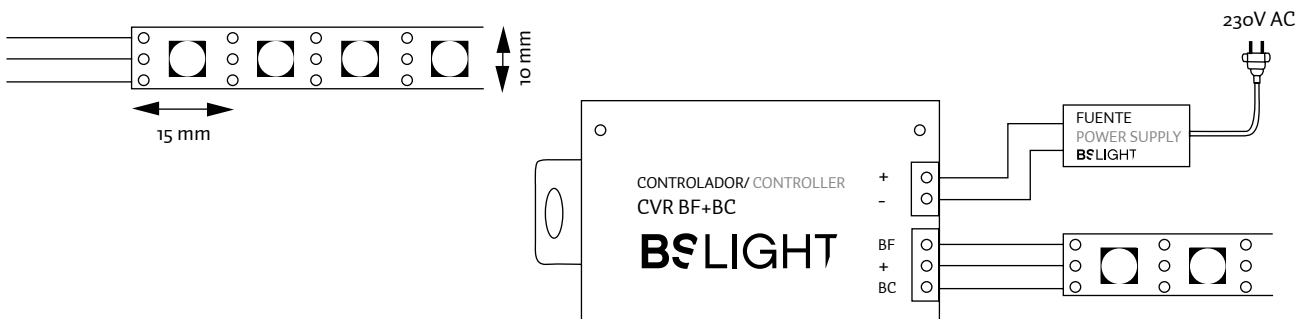

REFERENCIA REFERENCE	DESCRIPCIÓN DESCRIPTION	COLOR COLOR	PROTECCIÓN PROTECTION	ALIMENTACIÓN POWER SUPPLY	TIPO LED LED TYPE	CANT. mts Qty OF LED	FLUJO LUM. LUM. FLOW	CONSUMO CONSUME
TF5BF+BC	Tira 5 mts		IP33	12V DC	5050	150+150 LEDs	5625lm	72W
CVRBF+BC	Controlador Controller		IP33	12V DC	-	-	-	4W

Fuente de alimentación recomendada para un rollo de 5 mts FT244 o RS10024 (24V 100W). Para regular la tira led dual es preciso la instalación del equipo CVRBF+BC / Recommended power supply for a 5 mts roll: FT244 o RS10024 (24V 100W). To control the DUAL flexible strip the installation of the device CVRBF+BC is necessary



48 /

TIRAS FLEXIBLES 160 LEDS 5050 SERIE SMART SERIE SMART FLEXIBLE STRIPS 160 LEDS 5050

Rollo de tira flexible de 5 mts con 160 LEDS SMD 5050 RGB. Cada grupo de 2 LEDS dispone de un chip controlador para poder generar cientos de efectos diferentes. Se puede cortar cada 2 LEDS (60mm). Se suministra con adhesivo 3M de doble cara. Protección IP66. 48W de consumo total el rollo de 5 mts.

5 mts flexible strip roll with 160 LED SMD 5050 RGB. Each 2 LEDS has a PC board to generat thousand of differents effects. Can be cut every 2 LEDS (60mm). Provided with 3 mts double side adhesive. IP66 protection. 5 mts roll total consume is 48W.

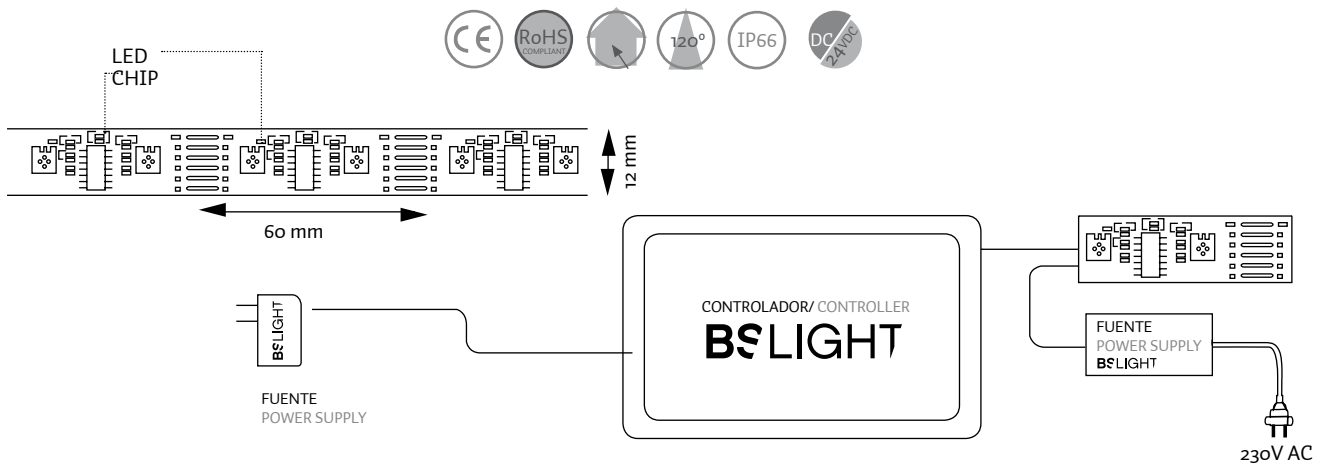

REFERENCIA REFERENCE	DESCRIPCIÓN DESCRIPTION	COLOR COLOR	PROTECCIÓN PROTECTION	ALIMENTACIÓN POWER SUPPLY	TIPO LED LED TYPE	CANT. mts Qty OF LED	FLUJO LUM. LUM. FLOW	CONSUMO CONSUME
TFSMART	Tira 5 mts	■ ■ ■	IP65	5V DC	5050	160LEDS/ mts	300-600-375lm	48W
CSMART	Controlador Controller		IP33	12V DC	-	-	-	4W

Fuente de alimentación recomendada para un rollo de 5 mts RS550 (5V 50W). Para regular la tira LED SMART es preciso la instalación del equipo CSMART / Recommended power supply for a 5 mts roll: RS550 (5V 50W)
To control the SMART flexible strip, the installation of the device CSMART is necessary.

CONECTORES Y EMPALMES SIN SOLDADURA

CONNECTORS AND JUNCTIONS WITHOUT WELDING

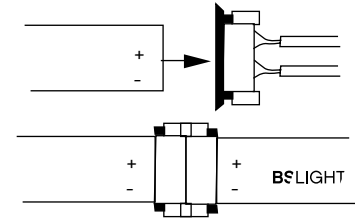

49 /

REFERENCIA
REFERENCE

DESCRIPCIÓN
DESCRIPTION

CTFC	Conector alimentación TF5 monocolor / Power supply connector single-color TF5
ETFC	Empalme para TF5 monocolor / Junction for single-color TF5
CTFRGB	Conector alimentación para TF5 RGB / Power supply connector RGB TF5
ETFRGB	Empalme para TF5 RGB / Junction RGB TF5

SERIE PROF



REFERENCIA
REFERENCE

DESCRIPCIÓN
DESCRIPTION

CTFC/2	Conector alimentación TF5 monocolor para tiras 8mm / Power supply connector single-color TF5 for 8mm strips
ETFC/2	Empalme para TF5 monocolor para tiras 8mm / Junction for single-color TF5 for 8mm strips
CTFC/2-10	Conector alimentación TF5 monocolor para tiras 10mm / Power supply connector single-color TF5 for 10mm strips
ETFC/2-10	Empalme para TF5 monocolor para tiras 10mm / Junction for single-color TF5 for 10mm strips
CTFRGB	Conector alimentación para TF5 RGB / Power supply connector RGB TF5
ETFRGB	Empalme para TF5 RGB / Junction for RGB TF5

TERMORRETRÁCTIL CON SILICONA

HEAT SHRINKING TUBE WITH SILICONE

Tubo termorretráctil con silicona interior para hacer estanca una conexión. Se suministra en tramos de 1 mt.
Heat shrinking tube with silicone inside to make it waterproof. The tubes are supplied in sections of 1 mt.



∅ 12,5 mm
diámetro /
diameter



REFERENCIA
REFERENCE

DESCRIPCIÓN
DESCRIPTION

XBDW-12.7-TR-1	Tubo termorretráctil 12,7mm - 1mts con silicona / Heat shrinkink tube 12,7mm – 1mt with silicone
----------------	--

PERFIL ALUMINIO REDONDO ROUND ALUMINUM PROFILE

Perfil de aluminio anodizado redondo con difusor ideal para tiras LED rígidas o flexibles. Tanto los perfiles como los difusores se entregan en tramos de 2 mts.

The round aluminum anodized profile is ideal for rigid or flexible LED strip. Diffusers and profiles are supplied 2 mts/pcs.

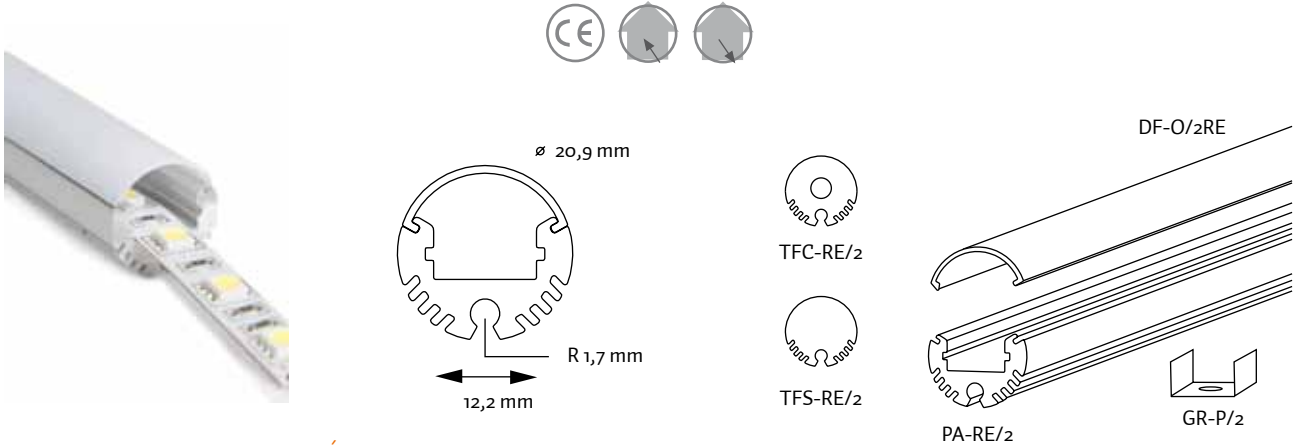

50 /

REFERENCIA DESCRIPCIÓN
REFERENCE DESCRIPTION

PA-RE/2	Perfil aluminio redondo / Round aluminium profile
TFS-RE/2	Tapón final para perfil redondo / End cap for round aluminum profile
TFC-RE/2	Tapón final para perfil redondo c/agujero / End cap with hole for round profile
DF-O/2RE	Difusor opal para perfil PA-RE/2 / Opal diffuser for PA-RE/2 profile
GR-P/2	Grapa sujeción para perfil / Profile's Clip

PERFIL ALUMINIO ESQUINERA CORNER ALUMINUM PROFILE

Perfil de aluminio anodizado de superficie esquinera con difusor ideal para tiras LED rígidas o flexibles. Tanto los perfiles como los difusores se entregan en tramos de 2 mts.

The corner aluminum anodized profile is ideal for rigid or flexible LED strip. Diffusers and profiles are supplied 2 mts/pcs.

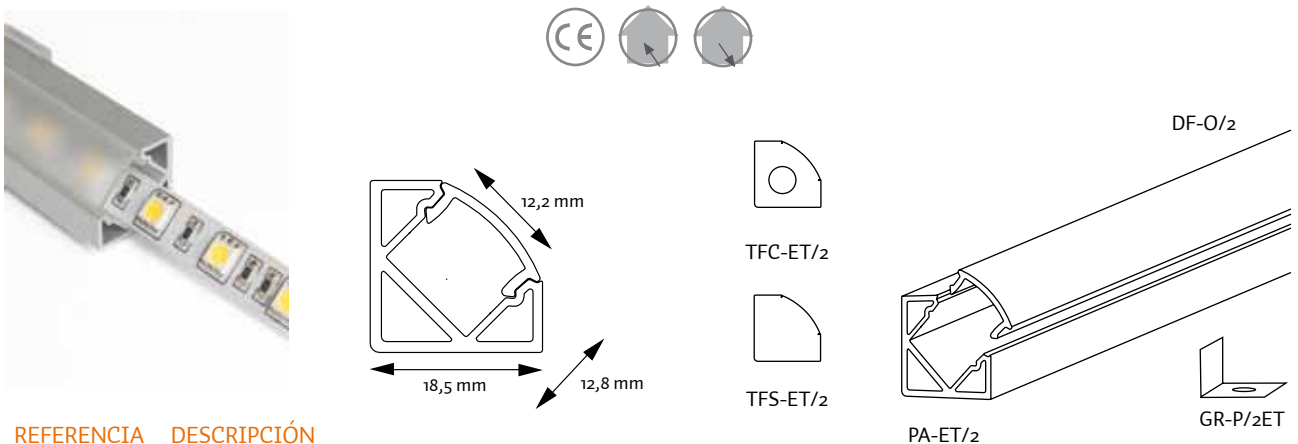

REFERENCIA DESCRIPCIÓN
REFERENCE DESCRIPTION

PA-ET/2	Perfil aluminio esquinera / Corner profile aluminium
TFS-ET/2	Tapón final para perfil esquinera ET / End cap for corner profile ET
TFC-ET/2	Tapón final para perfil esquinera ET c/agujero / End cap with hole for corner profile ET
DF-T/2	Difusor transparente perfil PA-SM, SE, EM, EE y ET / Transparent diffuser profile PA-SM, SE, EM, EE and ET
DF-O/2	Difusor opal perfil PA-SM, SE, EM, EE y ET / Opal diffuser profiles PA-SM, SE, EM, EE and ET
GR-P/2ET	Grapa sujeción para perfil esquinera PA-ET / Clip for corner profile PA-ET

PERFIL ALUMINIO ESTANCO WATERPROOF ALUMINUM PROFILE

Perfil de aluminio anodizado estanco con difusor ideal para tiras LED rígidas o flexibles. Tanto los perfiles como los difusores se entregan en tramos de 2 mts.

Anodized aluminum waterproof profile, with diffuser is ideal for rigid or flexible LED strip. Diffusers and profiles are supplied 2 mts/pcs. pieces.

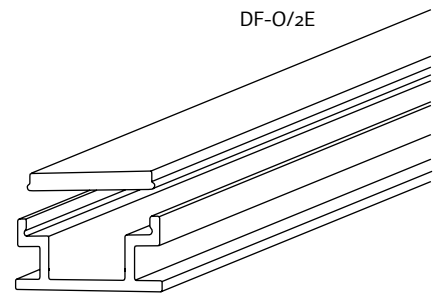
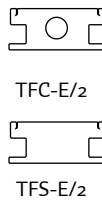
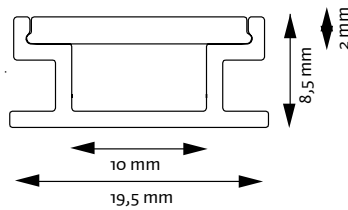

51 /

REFERENCIA
REFERENCE

DESCRIPCIÓN
DESCRIPTION

PA-E/2	Perfil aluminio empotrar estanco / Aluminum waterproof recessed profile
TFS-E/2	Tapón final para perfil estanco E / End cap for waterproof E profile
TFC-E/2	Tapón final para perfil estanco E c/agujero / End cap with hole for waterproof E profile
DF-O/2E	Difusor opal grueso para perfil PA-E / Opal thick diffuser for PA-E profile

PERFIL ALUMINIO CON CANAL ALUMINUM PROFILE WITH CHANNEL

Perfil de aluminio anodizado con canal con difusor ideal para tiras LED rígidas o flexibles. Tanto los perfiles como los difusores se entregan en tramos de 2 mts.

Anodized aluminum profile, with channel and diffuser, ideal for rigid or flexible LED strip. Diffusers and profiles are supplied 2 mts/pcs.

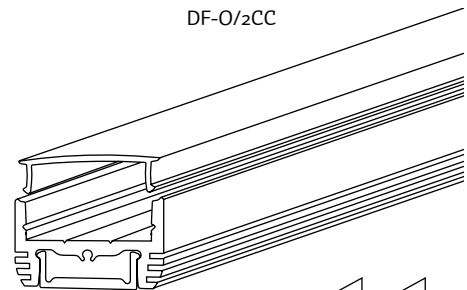
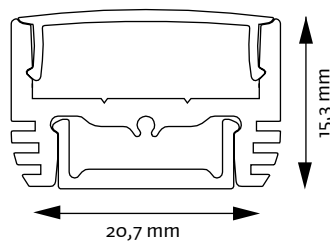

PA-CC/2

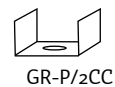

GR-P/2CC

REFERENCIA
REFERENCE

DESCRIPCIÓN
DESCRIPTION

PA-CC/2	Perfil aluminio con canal / Aluminum profile with channel
DF-O/2CC	Difusor opal para perfil con canal / Opal diffuser for profile with channel
DF-T/2CC	Difusor transparente para perfil con canal / Transparent diffuser for profile with channel
TFS-CC/2	Tapón final ciego para perfil con canal / End cap for profile with channel
TFC-CC/2	Tapón final con agujero para perfil con canal / End cap with hole for profile with channel
GR-P/2CC	Grapa para perfil con canal / Clip for profile with channel

PERFIL ALUMINIO ESQUINERA CUADRADOS

ALUMINUM SQUARE CORNER PROFILE

Perfil de aluminio anodizado de superficie esquinera con difusor cuadrado ideal para tiras LED rígidas o flexibles. Tanto los perfiles como los difusores se entregan en tramos de 2 mts.

Square aluminium profile is ideal for rigid or flexible LED strip. Diffusers and profiles are supplied 2 mts/pcs.

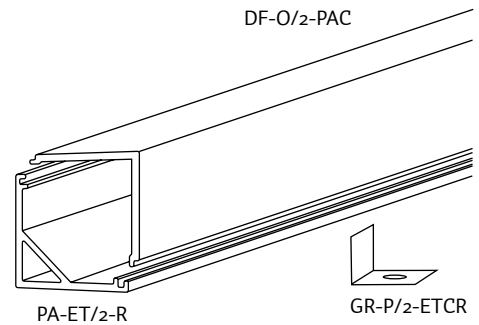
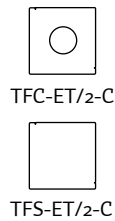
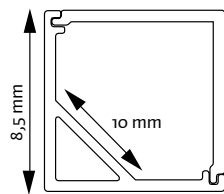

52 /

REFERENCIA DESCRIPCIÓN
REFERENCE DESCRIPTION

PA-ET/2-R	Perfil aluminio esquinera cuadrado / Aluminum square corner profile
DF-O/2-PAC	Difusor opal perfil esquinera cuadrado / Opal diffuser for square corner profile
TFS-ET/2C	Tapón final para perfil esquinera cuadrado / End cap for square corner profile
TFC-ET/2C	Tapón final para perfil esquinera cuadrado c/agujero / End cap with hole for square corner profile
GR-P/2-ETCR	Grapa perfil esquinera cuadrado-redondo / Profile's Clip for square or round profile

PERFIL ALUMINIO ESQUINERA REDONDO

ALUMINUM ROUND CORNER PROFILE

Perfil de aluminio anodizado de superficie esquinera con difusor redondo ideal para tiras LED rígidas o flexibles. Tanto los perfiles como los difusores se entregan en tramos de 2 mts.

Round aluminium profile is ideal for rigid or flexible LED strip. Diffusers and profiles are supplied 2 mts/pcs.

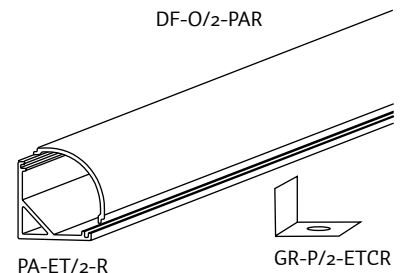
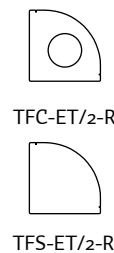
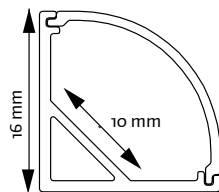

REFERENCIA DESCRIPCIÓN
REFERENCE DESCRIPTION

PA-ET/2-R	Perfil aluminio esquinera redondo / Aluminum corner round profile
DF-O/2-PAR	Difusor opal perfil esquinera redondo / Opal diffuser for round corner profile
TFS-ET/2R	Tapón final para perfil esquinera redondo / End cap for round corner profile
TFC-ET/2R	Tapón final para perfil esquinera redondo c/agujero / End cap with hole for round corner profile
GR-P/2-ETCR	Grapa perfil esquinera cuadrado-redondo / Clip for round or square corner profile

PERFIL ALUMINIO EMPOTRAR MINI MINI RECESSED ALUMINUM PROFILE

Perfil de aluminio anodizado para empotrar mini ideal para tiras LED rígidas o flexibles. Tanto los perfiles como los difusores se entregan en tramos de 2 mts.

The mini Anodized aluminum recessed profile is ideal for rigid or flexible LED strip. Diffusers and profiles are supplied 2 mts/pcs.

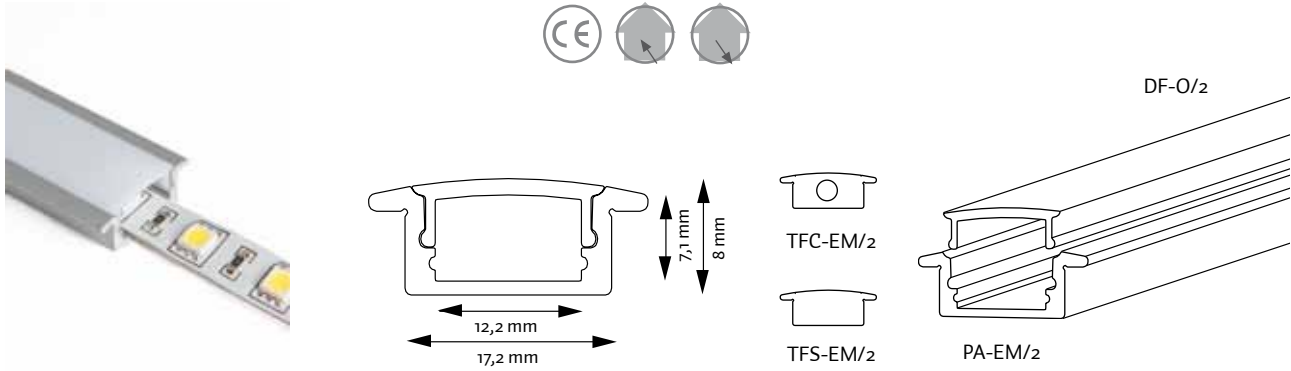

53 /

REFERENCIA DESCRIPCIÓN
REFERENCE DESCRIPTION

PA-EM/2	Perfil aluminio empotrar mini / Mini aluminum recessed profile
TFS-EM/2	Tapón final para perfil empotrar mini / End cap for mini recessed profile
TFC-EM/2	Tapón final para perfil empotrar mini con agujero / End cap for mini recessed profile with hole
DF-T/2	Difusor transparente perfil PA-SM, SE, EM, EE y ET / Transparent diffuser profile PA-SM, SE, EM, EE y ET
DF-O/2	Difusor opal perfil PA-SM, SE, EM, EE y ET / Opal diffuser for profile PA-SM, SE, EM, EE y ET

PERFIL ALUMINIO SUPERFICIE MINI MINI SURFACE ALUMINUM PROFILE

Perfil de aluminio anodizado mini ideal para tiras LED rígidas o flexibles. Tanto los perfiles como los difusores se entregan en tramos de 2 mts.

The mini Anodized aluminum recessed profile is ideal for rigid or flexible LED strip. Diffusers and profiles are supplied 2 mts/pcs.

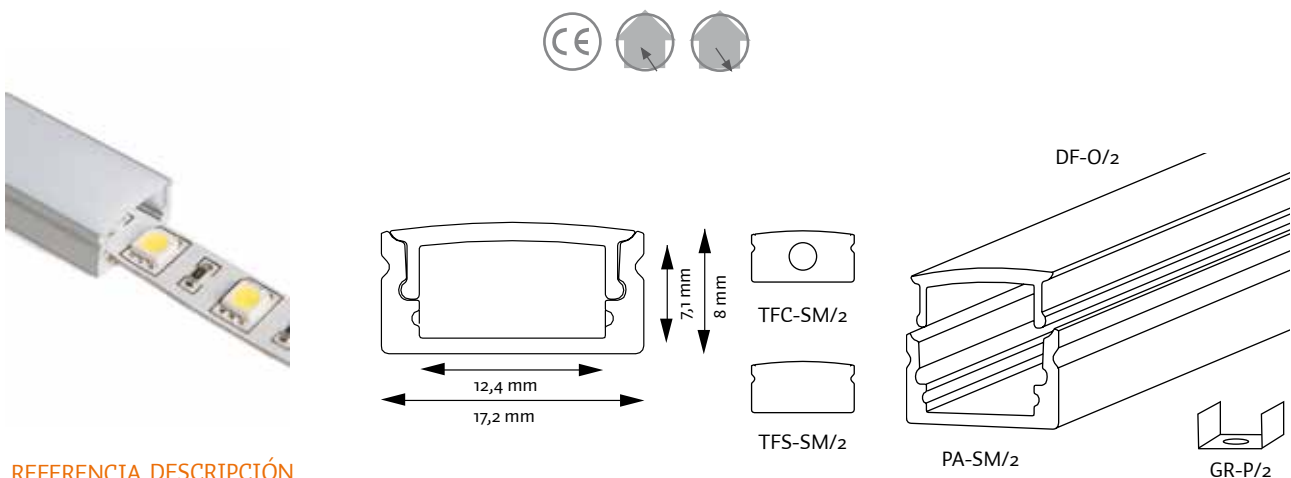

REFERENCIA DESCRIPCIÓN
REFERENCE DESCRIPTION

PA-SM/2	Perfil aluminio superficie mini / Mini aluminum surface profile
TFS-SM/2	Tapón final para perfil superficie mini / End cap for mini surface profile
TFC-SM/2	Tapón final para perfil superficie mini c/agujero / End cap for minisurface profile with hole
DF-T/2	Difusor transparente perfil PA-SM, SE, EM, EE y ET / Transparent diffuser profile PA-SM, SE, EM, EE y ET
DF-O/2	Difusor opal perfil PA-SM, SE, EM, EE y ET / Opal diffuser profile PA-SM, SE, EM, EE y ET
GR-P-2	Grapa sujeción perfil para PA-SM/2 / Clip profile PA-SM/2

PERFIL ALUMINIO EMPOTRAR ESTÁNDAR / ALUMINUM STANDARD RECESSED PROFILE

Perfil de aluminio anodizado para empotrar ideal para tiras led rígidas o flexibles. Tanto los perfiles como los difusores se entregan en tramos de 2 mts. / Anodized aluminum recessed profile, ideal for flexible or rigid strips. Diffusers and profiles are supplied 2 mts/pcs. pieces..

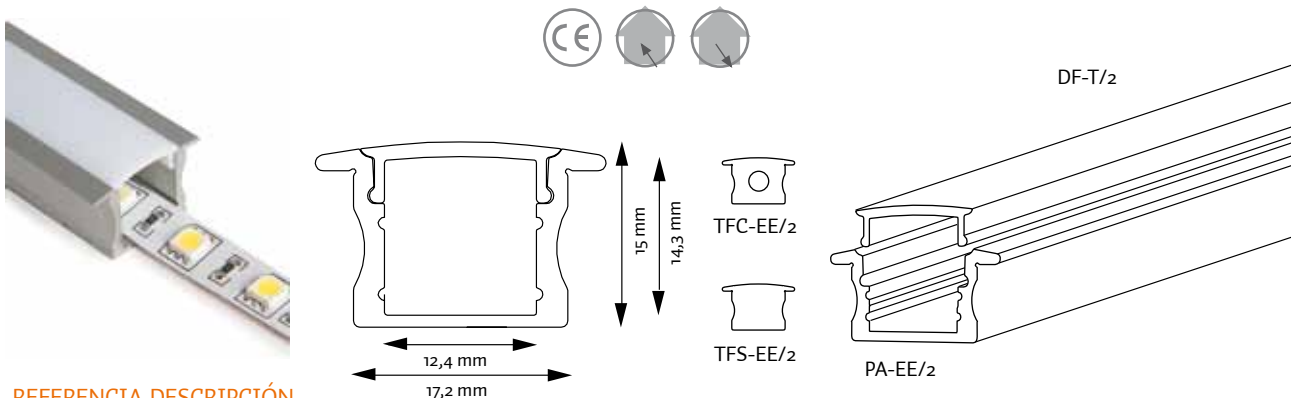

54 /

REFERENCIA DESCRIPCIÓN
REFERENCE DESCRIPTION

PA-EE/2	Perfil aluminio empotrar estándar / Aluminum standard recessed profile
TFS-EE/2	Tapón final para perfil empotrar estándar / End cap for standard recessed profile
TFC-EE/2	Tapón final para perfil empotrar estándar c/agujero / End cap with hole for standard recessed profile
DF-T/2	Difusor transparente perfil PA-SM, SE, EM, EE y ET / Transparent diffuser for profile PA-SM, SE, EM, EE and ET
DF-O/2	Difusor opal perfil PA-SM, SE, EM, EE y ET / Opal diffusotr for profiles PA-SM, SE, EM, EE y ET

PERFIL ALUMINIO SUPERFÍCIE ESTÁNDAR / ALUMINUM STANDARD SURFACE PROFILE

Perfil de aluminio anodizado de superficie ideal para tiras led rígidas o flexibles. Tanto los perfiles como los difusores se entregan en tramos de 2 mts. / Anodized aluminum surface profile, ideal for flexible or rigid strips. Diffusers and profiles are supplied 2 mts/pcs.

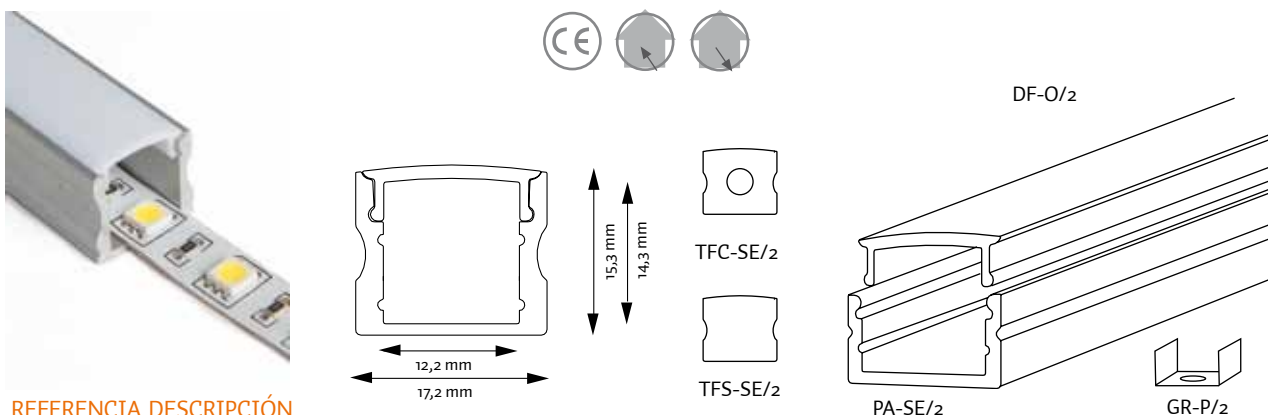

REFERENCIA DESCRIPCIÓN
REFERENCE DESCRIPTION

PA-SE/2	Perfil aluminio superficie estándar / Aluminum standard surface profile
TFS-SE/2	Tapón final para perfil estándar / End cap for standard profile
TFC-SE/2	Tapón final para perfil estándar c/agujero / End cap with hole for standard profile
DF-T/2	Difusor transparente perfil PA-SM, SE, EM, EE y ET / Transparent diffuser for profile PA-SM, SE, EM, EE and ET
DF-O/2	Difusor opal perfil PA-SM, SE, EM, EE y ET / Opal diffusotr for profiles PA-SM, SE, EM, EE y ET
GR-P/2	Grapa sujeción perfil para PA-SE/2 / Clip for PA-SE/2 profile

PERFIL ALUMINIO 16MM CON ÓPTICA

16MM ALUMINUM PROFILE WITH OPTIC DIFFUSER

Perfil de aluminio anodizado de 16mm de interior con óptica y difusor 60° ideal para tiras LED rígidas o flexibles. Tanto los perfiles como los difusores se entregan en tramos de 2 mts. / The 16mm anodized aluminum profile with optic diffuser 60° is ideal for rigid or flexible LED strip. Diffusers and profiles are supplied 2 mts/pcs..

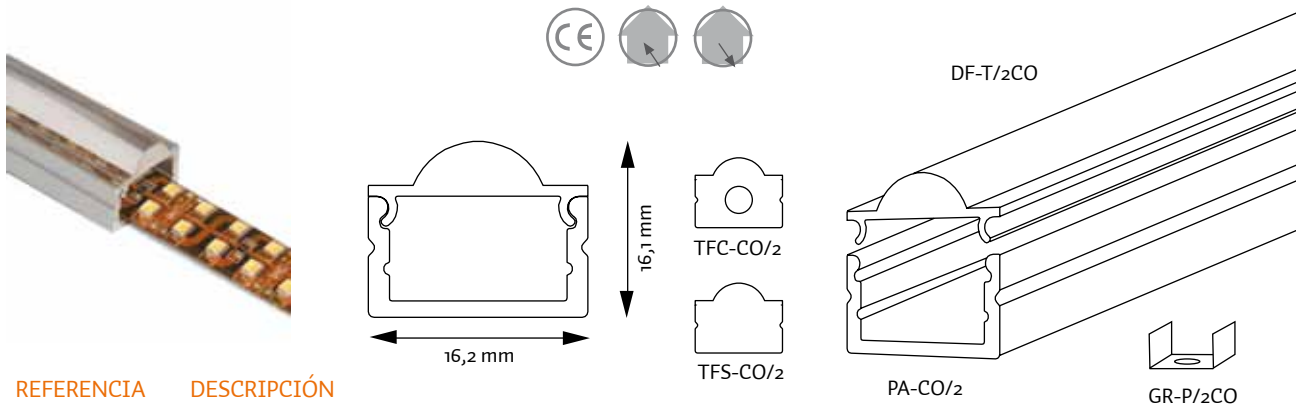

55 /

REFERENCIA DESCRIPCIÓN
REFERENCE DESCRIPTION

PA-CO/2	Perfil aluminio tipo U / Aluminum profile type U
DF-T/2CO	Difusor transparente con óptica 60° / 60° optic transparent diffuser
TFS-CO/2	Tapón final ciego / End cap
TFC-CO/2	Tapón final con agujero / End cap with hole
GR-P/2CO	Grapa perfil CO/2 / CO/2 profile's clip

PERFIL ALUMINIO 16 MM REDONDO

16 MM ROUND ALUMINUM PROFILE

Perfil de aluminio anodizado de 16mm de interior con difusor redondo alto ideal para tiras LED rígidas o flexibles. Tanto los perfiles como los difusores se entregan en tramos de 2 mts. / The 16mm anodized aluminum profile with round diffuser is ideal for rigid or flexible LED strip. Diffusers and profiles are supplied 2 mts/pcs.

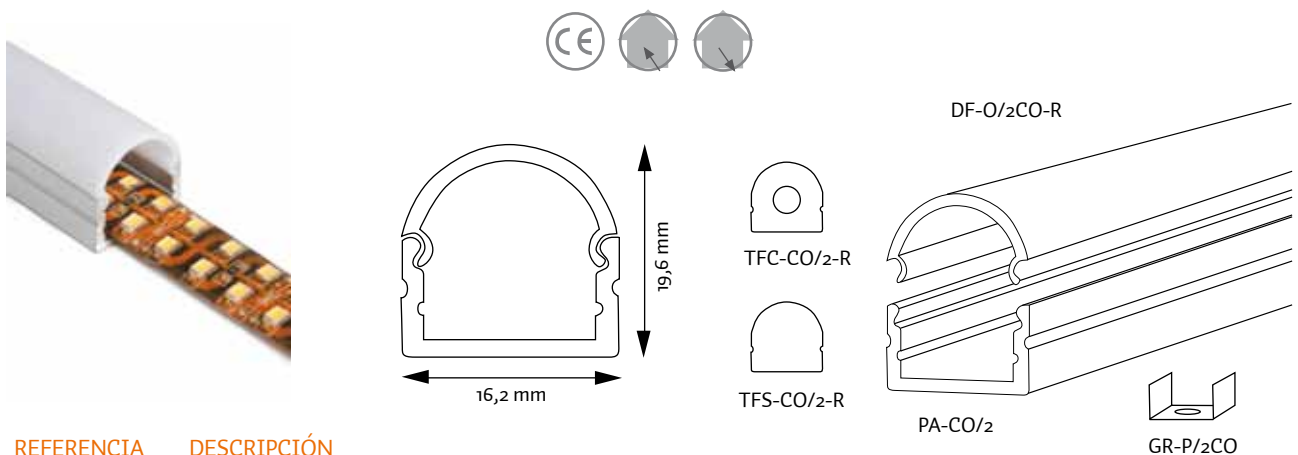

REFERENCIA DESCRIPCIÓN
REFERENCE DESCRIPTION

PA-CO/2	Perfil aluminio tipo U / Aluminum profile type U
DF-O/2CO-R	Difusor opal mate redondo perfil CO/2 / Matt opal round diffuser for CO/2 profile
TFS-CO/2-R	Tapón final ciego / End cap
TFC-CO/2-R	Tapón final con agujero / End cap with hole
GR-P/2CO	Grapa perfil CO/2 / CO/2 clip profile

PERFIL ALUMINIO 16MM CUADRADO 16MM ALUMINUM SQUARE PROFILE

Perfil de aluminio anodizado de 16mm de interior difusor cuadrado alto ideal para tiras LED rígidas o flexibles. Tanto los perfiles como los difusores se entregan en tramos de 2 mts. / Anodized aluminum profile of 16mm surface, with Square diffuser for rigid or flexible LED strip. Diffusers and profiles are supplied 2 mts/pcs.

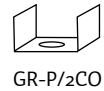
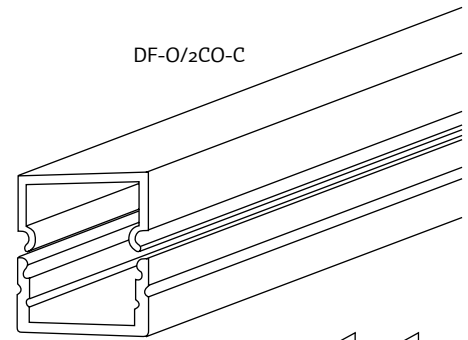
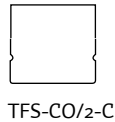
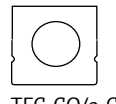
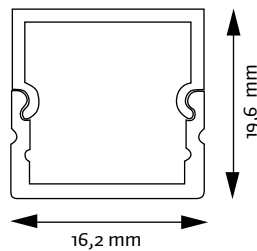

56 /

REFERENCIA
REFERENCE

DESCRIPCIÓN
DESCRIPTION

PA-CO/2	Perfil aluminio con óptica / Aluminum profile with optic lens
DF-O/2CO-C	Difusor opal mate cuadrado perfil CO/2 / Matt, opal, square diffuser CO/2 profile
TFS-CO/2-C	Tapón final ciego para CO/2 cuadrado / End cap for square CO/2 profile
TFC-CO/2-C	Tapón final con agujero para CO/2 cuadrado / End cap with hole for square CO/2 profile
GR-P-2CO	Grapa perfil CO/2 / CO/2 clip profile

PERFIL ALUMINIO ELH ELH ALUMINUM PROFILE

Perfil de aluminio serie ELH. Tanto los perfiles como los difusores se entregan en tramos de 3 mts.
ELH aluminium profile. Diffusers and profiles are supplied 3 mts/pcs.

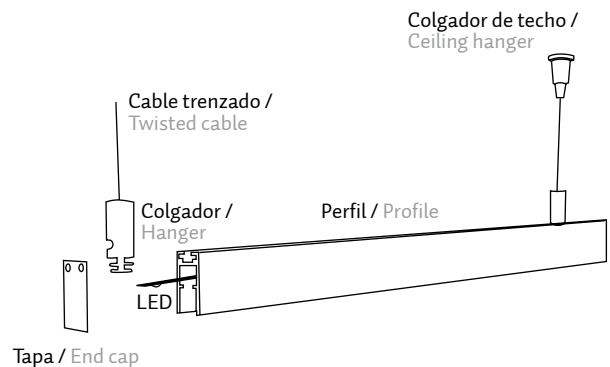
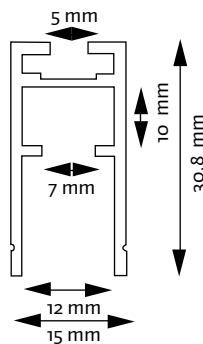

REFERENCIA
REFERENCE

DESCRIPCIÓN
DESCRIPTION

PA-ELH	Perfil aluminio para estantes luminosos ELH / Aluminum profile for ELH shelf lighting
TSA7	Tapón final para perfil PA-ELH / End cap for PA-ELH profile
C-ELH	Colgador para perfil ELH / ELH profile's hanger
GP-ELH	Grapa pared para colgador ELH / Wall-clip for ELH hanger
CA-ELH	Cable de acero para colgador ELH / Iron cable for ELH hanger
E-ELH	Escuadra para ELH / Flat L-bracket for ELH

03

FUENTES Y

CONTROLADORES

DRIVERS AND

CONTROLLERS



58 /

FUENTES DE CORRIENTE CONSTANTE CONSTANT CURRENT DRIVERS

Fuentes de corriente constante para alimentar con señal precisa a equipos LED de potencia 1W, 3W, 5W.
Constant current drivers to supply 1W, 3W and 5W LED devices with a precise signal.

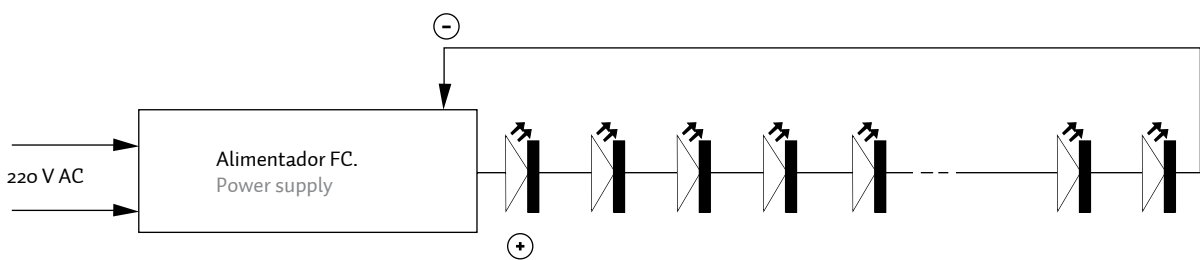

REFERENCIA REFERENCE	ALIMENTACIÓN POWER SUPPLY	SALIDA OUTPUT	MEDIDA MEASURE	APROPIADO SUITABLE	CONEXIÓN CONNECTION
FC3501X1	170-230V AC	350mA	43x24,5x19 mm	1 LED de / of 1W	con cable / with cable
FC3503X1	170-230V AC	350mA	43x24,5x19 mm	3 LEDS de / of 1W	por tornillos / with screws
FC3509X1	170-230V AC	350mA	118x38x22 mm	9 LEDS de / of 1W	por tornillos / with screws
FC35012X1	170-230V AC	350mA	118x38x22 mm	12 LEDS de / of 1W	por tornillos / with screws
FC35018X1	170-230V AC	350mA	118x38x22 mm	18 LEDS de / of 1W	por tornillos / with screws
FC7001X3	170-230V AC	700mA	43x24,5x19 mm	1 LED de / of 1W	con cable / with cable

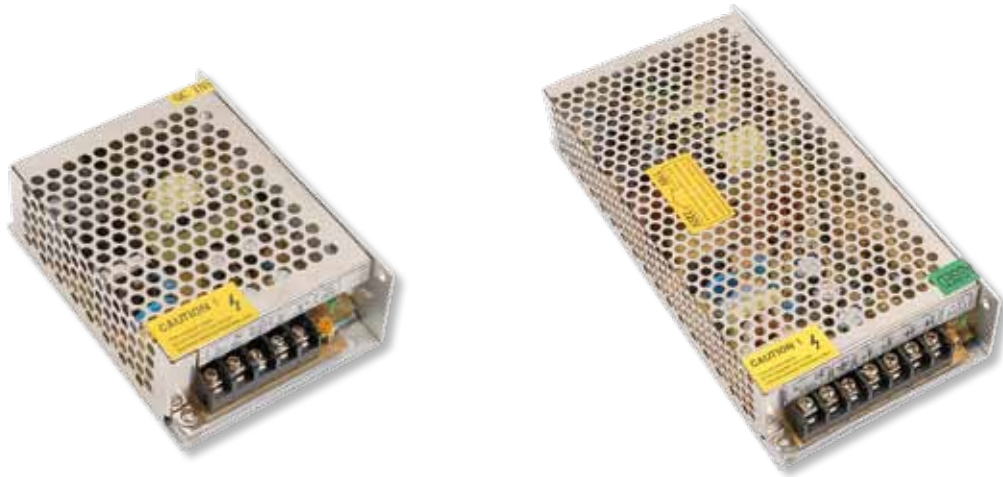

59 /

FUENTES DE TENSIÓN CONSTANTE PARA INTERIOR INDOOR CONSTANT TENSION DRIVERS

Fuentes conmutadas de tensión constante 12V DC o 24V DC para una señal precisa en la alimentación de equipos LED.
Constant tension drivers 12V DC or 24V DC supply LED device with a precise signal.

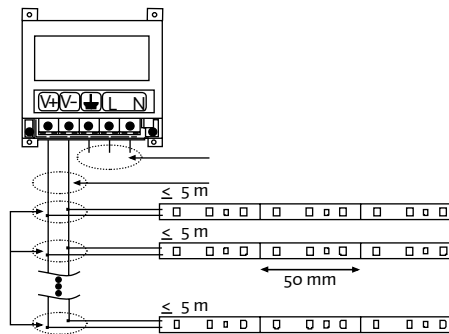

REFERENCIA ENTRADA	TENSIÓN	POTENCIA	MEDIDA	REFERENCIA ENTRADA	TENSIÓN	POTENCIA	MEDIDA		
REFERENCE INPUT	TENSION	POWER	MESURE	REFERENCE INPUT	TENSION	POWER	MESURE		
FT120,25	170-230V AC	12V DC	3W	45x38x19mm	SP20012	170-230V AC	12V DC	200W	199x98x50mm
FT120,75	170-230V AC	12V DC	9W	118x38x22mm	SP24012	170-230V AC	12V DC	240W	199x93x50mm
FT121,25	170-230V AC	12V DC	15W	118x38x22mm	FT241	170-230V AC	24V DC	25W	84x58x38mm
FT122	170-230V AC	12V DC	25W	84x58x38mm	FT242	170-230V AC	24V DC	60W	159x98x38mm
FT123	170-230V AC	12V DC	40W	129x98x38mm	FT244	170-230V AC	24V DC	100W	199x98x38mm
FT125	170-230V AC	12V DC	60W	159x98x38mm	RS15024	170-230V AC	24V DC	150W	199x98x38mm
FT128	170-230V AC	12V DC	100W	199x98x38mm	SP20024	170-230V AC	24V DC	200W	199x98x50mm
RS15012	170-230V AC	12V DC	150W	199x98x38mm	SP24024	170-230V AC	24V DC	240W	199x93x50mm



60 /

FUENTES DE TENSIÓN CONSTANTE PARA EXTERIOR

OUTDOOR CONSTANT TENSION DRIVERS

Fuentes conmutadas de tensión constante 12V DC o 24V DC de uso exterior con protección IP67 para una señal precisa en la alimentación de equipos LED.

Constant tension drivers 12V DC or 24V DC with IP67 protection for outdoor use. Supply LED device with a precise signal.

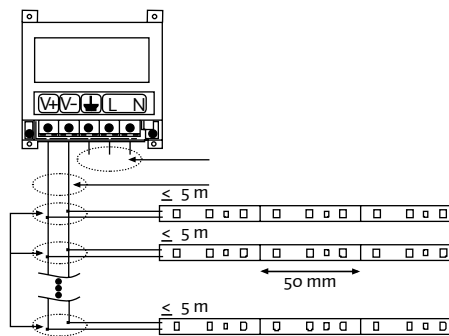

REFERENCIA ENTRADA	TENSIÓN	W	MEDIDA	REFERENCIA ENTRADA	TENSIÓN	W	MEDIDA
REFERENCE INPUT	TENSION	W	MEASURE	REFERENCE INPUT	TENSION	W	MEASURE
LPV2012	170-250V AC	12V DC	20W 148x40x30mm	LPV2024	170-250V AC	24V DC	20W 148x40x30mm
LPV3512	170-250V AC	12V DC	35W 148x40x30mm	LPV3524	170-250V AC	24V DC	35W 148x40x30mm
LPV6012	170-250V AC	12V DC	60W 162,5x42,5x32mm	LPV6024	170-250V AC	24V DC	60W 162,5x42,5x32mm
LPV10012	170-250V AC	12V DC	100W 190x52x37mm	LPV10024	170-250V AC	24V DC	100W 190x52x37mm
CLG15012A	170-250V AC	12V DC	150W 222x38x68,8mm	CLG15024A	170-250V AC	24V DC	150W 222x38x68,8mm



RRGB



CVRRGB-L



CVRRGB-T



CVRRGB-E

CONTROLADORES RGB RGB CONTROLLERS

Controladores RGB manual o vía radio con múltiples funciones de selección de programa, velocidad y luminosidad. Salida PWM para control de dispositivos LED PWM de ánodo común.

Manual or via radio RGB controllers with multifunctions: programme, speed and brightness. PWM output for the control of common anode PWM LED devices.

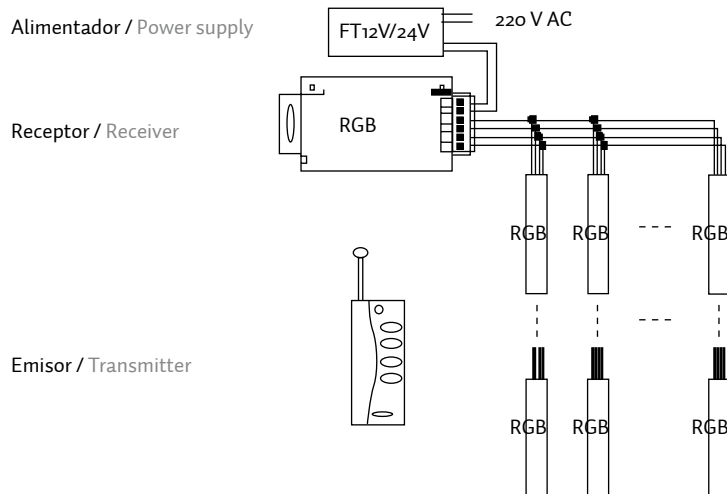

REFERENCIA REFERENCE	ALIMENTACIÓN POWER SUPPLY	SALIDA OUTPUT	CARGA MÁX. MAX. CHARGE	MEDIDA MEASURE	CONEXIÓN CONNECTION
RRGB	12-24V DC	PWM 12-24V DC	3A canal/channel	130x40x51mm	Controlador manual / Manual controller
CVRRGB-L	12-24V DC	PWM 12-24V DC	3A canal/channel	130x40x51mm	Controlador con control en receptor Controller with control as receiver
CVRRGB-E	12-24V DC	PWM 12-24V DC	4A canal/channel	104x65x24mm	Controlador con mando multi botón Controller with multi-button remote control
CVRRGB-T	12-24V DC	PWM 12-24V DC	5A canal/channel	40x65x23mm	Controlador con mando touch / Controller with touch remote control

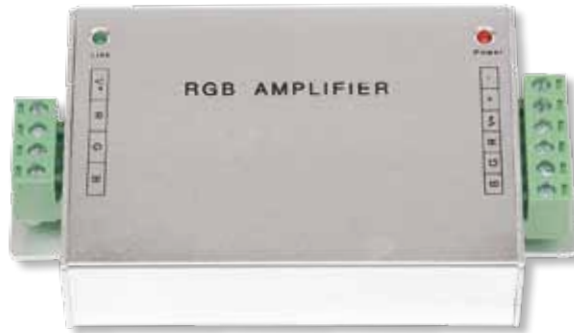

62 /

AMPLIFICADOR RGB RGB AMPLIFIER

Amplificador RGB para ampliar las instalaciones con un solo controlador en instalaciones RGB. Amplificador de señal PWM.
RGB Amplifier to extend RGB installations with only one controller. PWM signal amplifier.

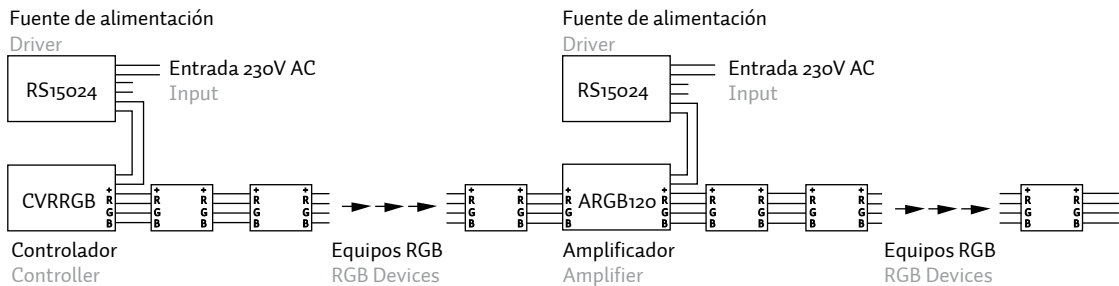
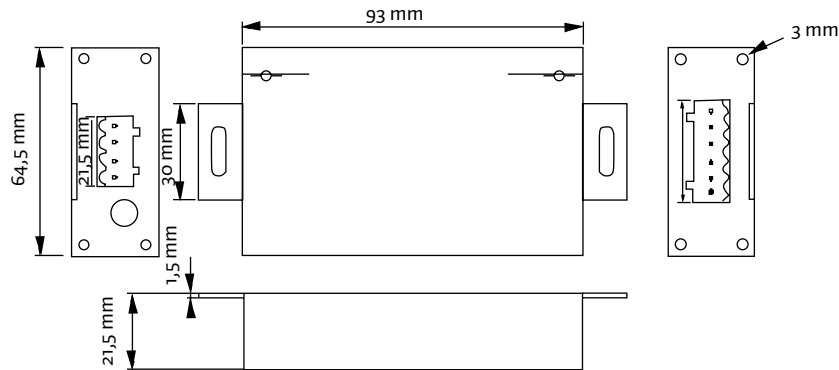

REFERENCIA REFERENCE	SEÑAL ENTRADA INPUT SIGNAL	SEÑAL SALIDA OUTPUT SIGNAL	ALIMENTACIÓN POWER SUPPLY	CARGA MÁX. MAX. CHARGE	MEDIDA MEASURE
ARGB120-T	PWM 12-24V DC	PWM 12-24V DC	12-24V DC	5A por 3 canales / channels	104x65x24mm



RMC



RMC-VR



RMC-S

63 /

REGULADORES MONOCOLOR PWM SINGLE-COLOUR PWM REGULATORS

Controladores monocolor manual o vía radio con múltiples funciones de selección de programa y luminosidad. Salida PWM para control de dispositivos LED PWM de 12V o 24V.

Single-color Manual or via radio controllers with multifunctions program selection and lightness. PWM output for PWM LED control devices of 12V or 24V.



RMC-S

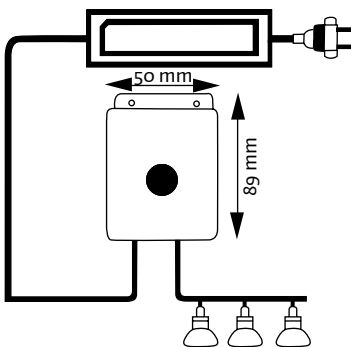

RMC

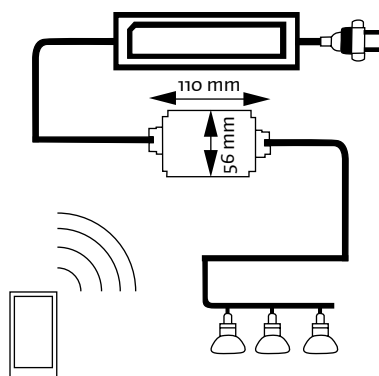

RMC-VR

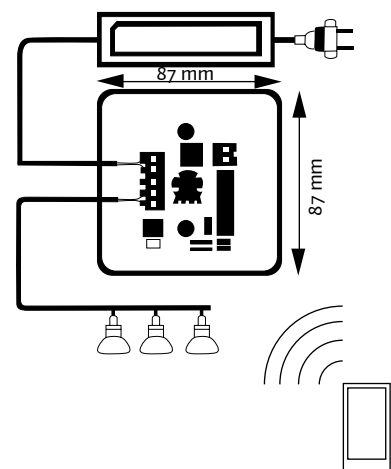

REFERENCIA REFERENCE	ALIMENTACIÓN POWER SUPPLY	SALIDA OUTPUT	CARGA MÁX. MAX. CHARGE	MEDIDA MEASURE	COMENTARIO REMARKS
RMC-S	12-24V DC	PWM 12-24V DC	8A	89x50x58mm	Regulador manual / Manual regulator
RMC	12V DC	PWM 12V DC	8A	110x56x34mm	Regulador vía radio / Regulator via radio
RMC-VR	12-24V DC	PWM 12-24V DC	8A	87x87mm	Regulador manual-infrarrojo / Infra-red manual regulator



64 /

REGULADORES 0-10V

0-10V DIMMERS

Regulador con entrada para protocolo 0-10V para regulación de equipos LED por tensión PWM 12/24V o por corriente constante 350mA y 700mA.
Dimmers with input for 0-10V protocol to control the LED devices with PWM tension 12/24V or drivers current 350mA and 700mA.

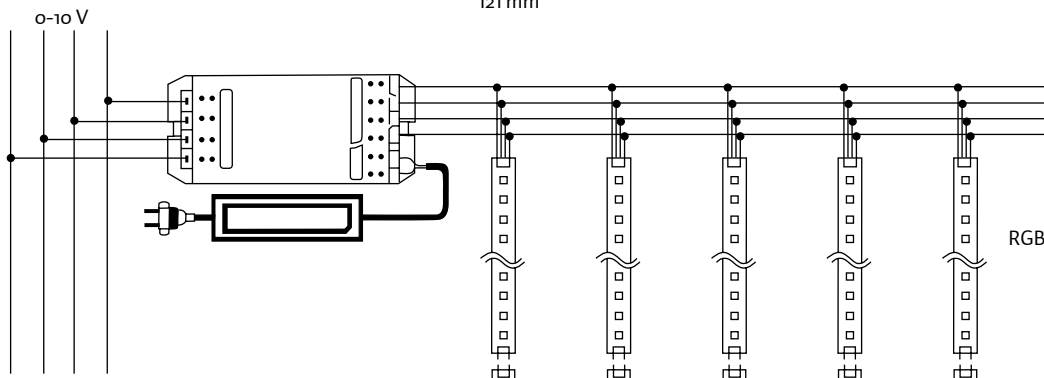
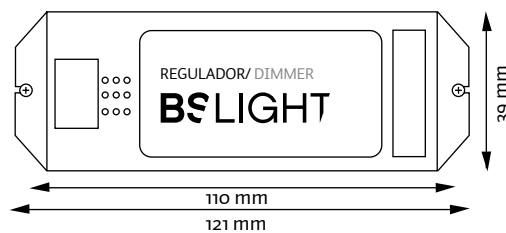

REFERENCIA REFERENCE	SEÑAL ENTRADA INPUT SIGNAL	SEÑAL SALIDA OUTPUT SIGNAL	ALIMENTACIÓN POWER SUPPLY	CARGA MÁX. MAX. CHARGE	CARGA MÁX. MAX. CHARGE	MEDIDA MEASURE
BS-010-5	Tensión 0-10V	3 canales / channel PWM	12-24V DC	5A / 3 canales / channel	360W (24V)	121x39x39mm
BS-010-10	Tensión 0-10V	1 canal / channel PWM	12-24V DC	10A / 1 canal / channel	240W (24V)	121x39x39mm
BS-010-350	Tensión 0-10V	1 canal / channel CC	12-48V DC	350mA CC	1-12 LEDS 1W	121x39x39mm
BS-010-750	Tensión 0-10V	1 canal / channel CC	12-48V DC	700mA CC	1-12 LEDS 3W	121x39x39mm
BS-010-1050	Tensión 0-10V	1 canal / channel CC	12-48V DC	1050mA CC	1-12 LEDS 5W	121x39x39mm



65 /

REGULADORES DALI DALI DIMMER

Regulador con entrada para protocolo DALI para regulación de equipos LED por tensión PWM 12/24V o sistema analógico 0-10V.
Dimmer for DALI protocol to control the LED devices with PWM 12/24V or analogue system 0-10V.

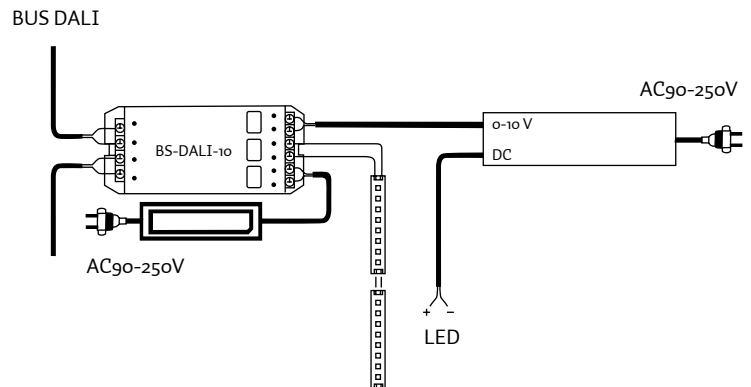
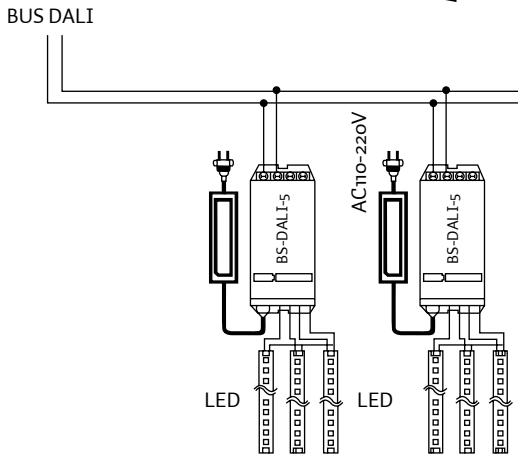
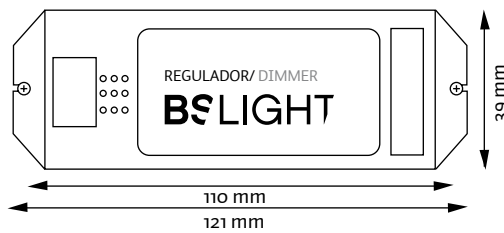

REFERENCIA REFERENCE	SEÑAL ENTRADA INPUT SIGNAL	SEÑAL SALIDA OUTPUT SIGNAL	ALIMENTACIÓN POWER SUPPLY	CARGA MÁX. MAX. CHARGE	MEDIDA MEASURE
BS-DALI-5	DALI	PWM 12-24V DC	12-24V DC	5A3 canal / channel	121x39x39mm
BS-DALI-10	DALI	PWM 12-24V DC y 0-10V	12-24V DC	10A canal / channel	121x39x39mm



66 /

CONTROLADOR WIFI PARA IPHONE, IPAD O ANDROID

WIFI CONTROLLER FOR IPHONE, IPAD OR ANDROID

Controlador wifi para iluminación LED con equipo vía radio. Compatible con sistema IOS para utilizar con Iphone, Ipad y con Smartphones con sistema Android. La app Magic Color, tanto para IOS como Android se suministra con el producto, y puede instalarse para IOS, a través de iTunes.

Wifi controller for LED lighting with via radio. We can use IOS system for Iphone , Ipad and Android systems for Smartphones. Included the APP Magic Color for Android and we can use iTunes to download for IOS sytem.

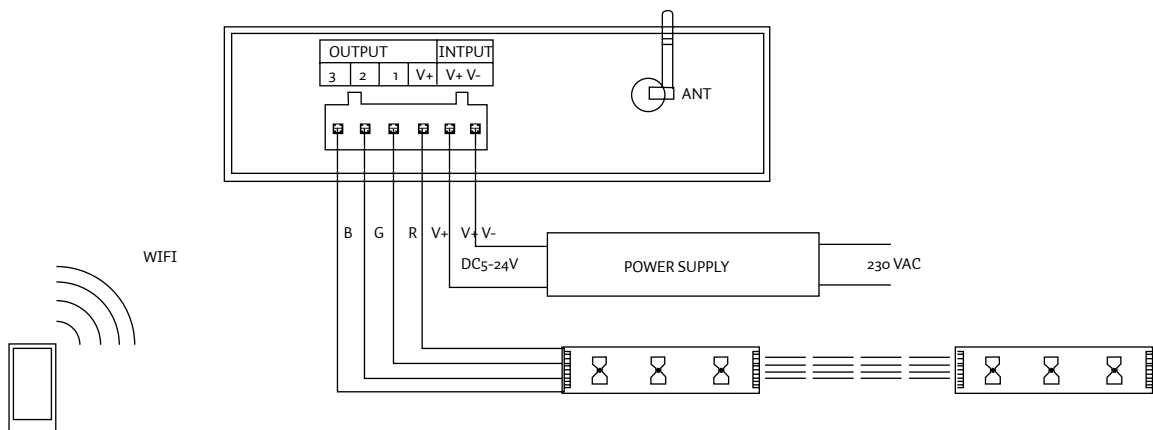

REFERENCIA REFERENCE	ALIMENTACIÓN POWER SUPPLY	SEÑAL SALIDA OUTPUT SIGNAL	CARGA MÁX. MAX. CHARGE	MEDIDA MEASURE	COMENTARIO REMARKS
CVRRGB-WIFI	5-24V DC	PWM 5-24V DC	4A canal / channel	107x65x30mm	Incluye software control Control software includes

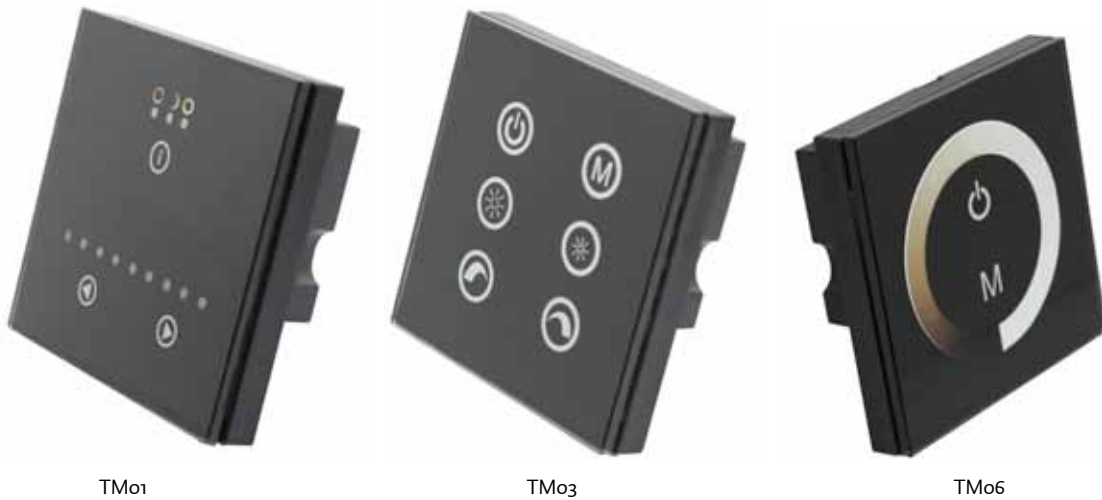

67 /

PANEL TÁCTIL MURAL TOUCH PANEL MURAL

Paneles táctiles de instalación mural para el control de equipos monocolor y RGB. Equipos preprogramados con diversos programas de color, luminosidad, temperatura de color... Diseñado para ser integrado e instalado en cajetín empotrado estándar en pared.
Touch panels for wall installation to control single-color and RGB equipments. Pre programmed equipments with several color programs, lightness, color temperature... To be recessed wall with a junction box.

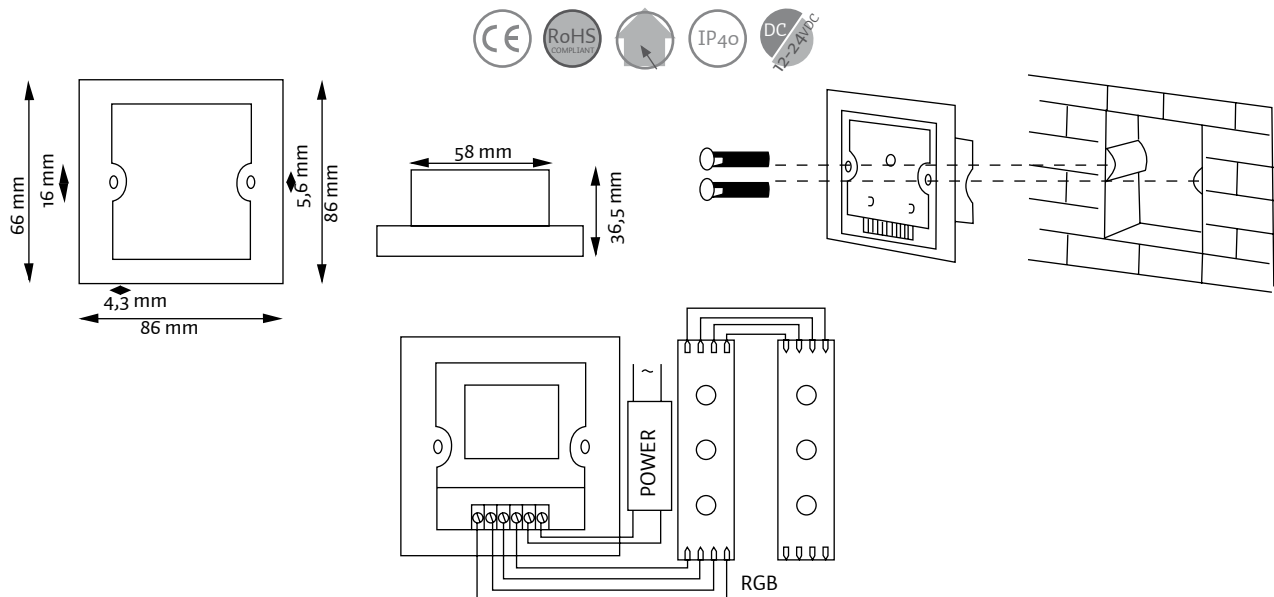

REFERENCIA REFERENCE	ALIMENTACIÓN POWER SUPPLY	SEÑAL SALIDA OUTPUT SIGNAL	CARGA MÁX. MAX. CHARGE	MEDIDA MEASURE	CONECTORES CONNECTORS
TM06	12-24V DC	1 canal/ channel PWM	4A canal channel	86x86x37mm	Regulador Monocolor (Intensidad de la luz monocolor) Monocolor dimmer (Monocolor intensity of light)
TM03	12-24V DC	3 canales/ channel PWM	4A canal channel	86x86x37mm	Controlador RGB (Color, regulador y velocidad RGB) RGB controller (Color, dimmer and velocity RGB)
TM01	12-24V DC	3 canales/ channel PWM	4A canal channel	86x86x37mm	Controlador Multifunción (Color, regulador y velocidad RGB y monocolor) Multifunction controller (Color, RGB and monocolor dimmer and velocity)



68 /

DECODIFICADOR DMX DMX DECODER

Decodificador con entrada por protocolo DMX y salida PWM para el control de Tiras flexibles, rígidas, bañadores de pared, bombillas... Entrada por conector XLR-3 y RJ45.
DMX decoder with input for protocol and output PWM for the control of flexible or rigid strips, wall washers, bulbs... Input with XLR-3 and RJ45 connectors.

INSTALACIÓN BÁSICA BASIC INSTALLATION

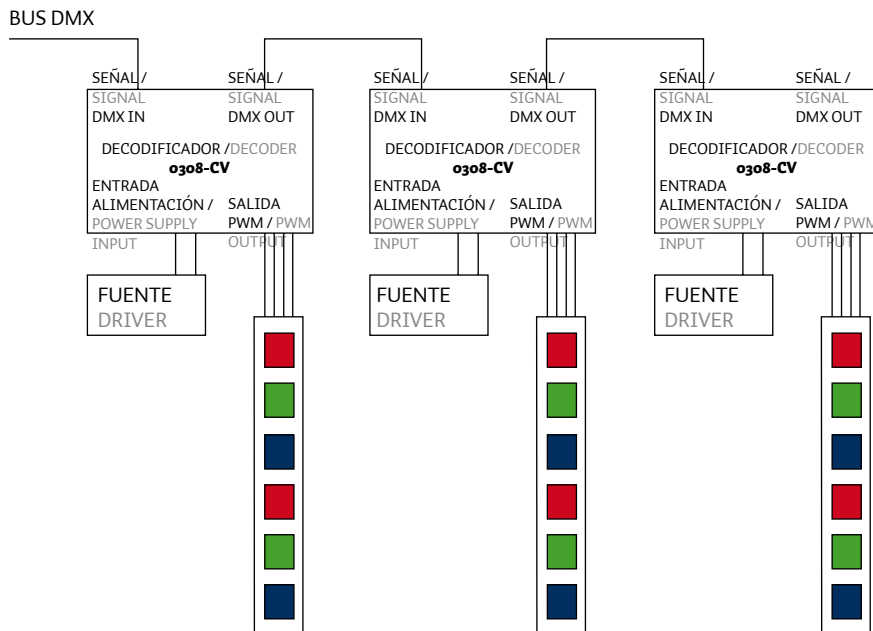

REFERENCIA REFERENCE	SEÑAL ENTRADA INPUT SIGNAL	SEÑAL SALIDA OUTPUT SIGNAL	ALIMENTACIÓN POWER SUPPLY	CARGA MÁX. MAX. CHARGE	MEDIDA MEASURE	CONECTORES CONNECTORS
o3o8-CV	DMX512/1990	PWM 12-24V DC	12-24V DC	4A-3 canal / channel	166x67x41mm	Canon - RJ45
o3o8-CV-35o	DMX512/1990	PWM 350mA	12-48V DC	1 a 12 LEDs 1W-3 canal / channel	166x67x41mm	Canon - RJ45
o3o8-CV-7oo	DMX512/1990	PWM 700mA	12-48V DC	1 a 12 LEDs 3W-3 canal / channel	166x67x41mm	Canon - RJ45



69 /

INTERFACE USB-DMX USB-DMX INTERFACE

Interface USB a DMX que convierte la señal proveniente del USB del PC al protocolo DMX512. Se entrega con drivers y programa de gestión. Mediante el software incluido, se puede programar en el PC las escenas que queremos crear. DXPACK01 debe conectarse permanentemente al PC para generar el programa, DXPACKU6 puede funcionar de forma autónoma.

USB-DMX interface that converts the USB signal from the PC to the protocol DMX512. Drivers and control software included. Using the software, the sequences can be programmed in the PC. To operate the program, the DXPACK01 must be continuously connected to the PC whereas the DXPACKU6 is stand-alone and can work independently.

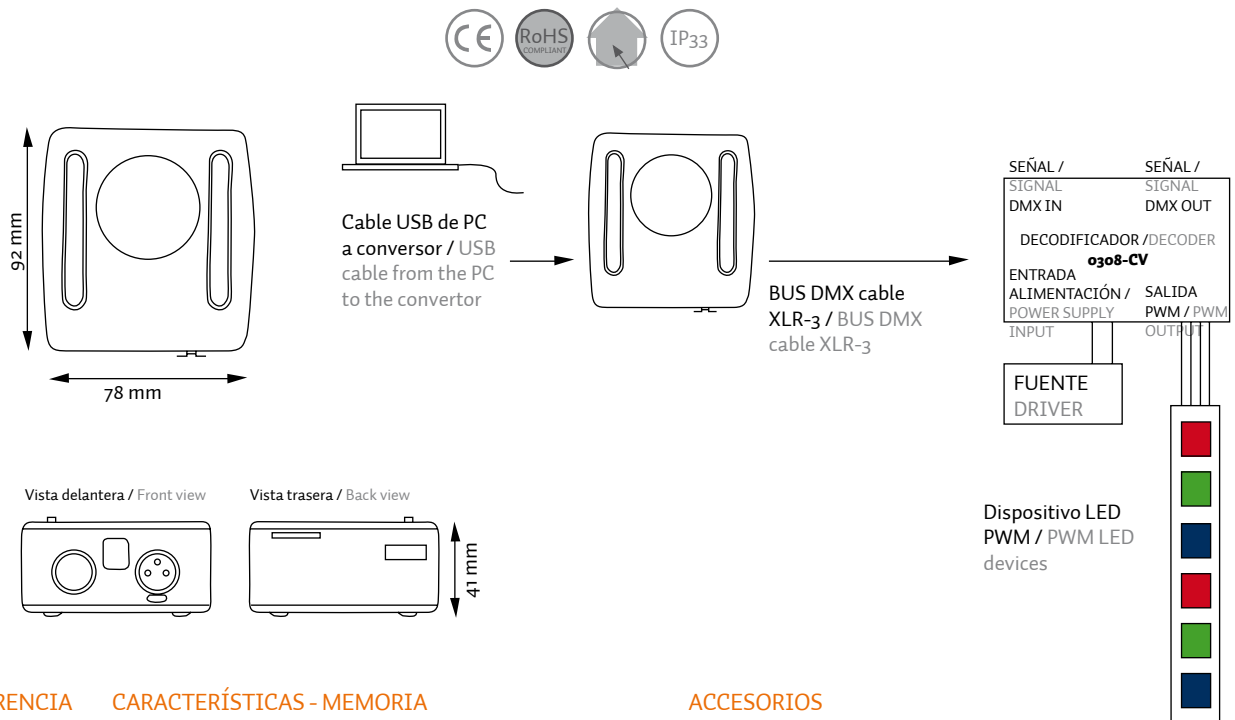

REFERENCIA
REFERENCE

CARACTERÍSTICAS - MEMORIA
CHARACTERISTICS - MEMORY

ACCESORIOS
ACCESSORIES

DXPACK01	Live mode. Conexión permanente a PC / Live mode. Continuous connection to the PC	Cable, manual, drivers y programa / Wire, instructions, drivers and software
DXPACKU6	5K. 128 canales. 20 escenas / 5K. 128 channels. 20 sequences	Cable, manual, drivers y programa / Wire, instructions, drivers and software



70 /

INTERFACE USB-DMX PANEL TÁCTIL TOUCH PANEL USB-DMX INTERFACE

Interface USB a DMX con panel táctil para instalar en pared que convierte la señal proveniente del USB del PC al protocolo DMX512. Se entrega con drivers y programa de gestión. Mediante el software incluido, se puede programar en el PC las escenas que queremos crear. USB-DMX interface with touch panel to be fixed on the wall. Convert the USB signal from the PC to the protocol DMX512. Drivers and control software included. Using the software, the sequences can be programmed in the PC.

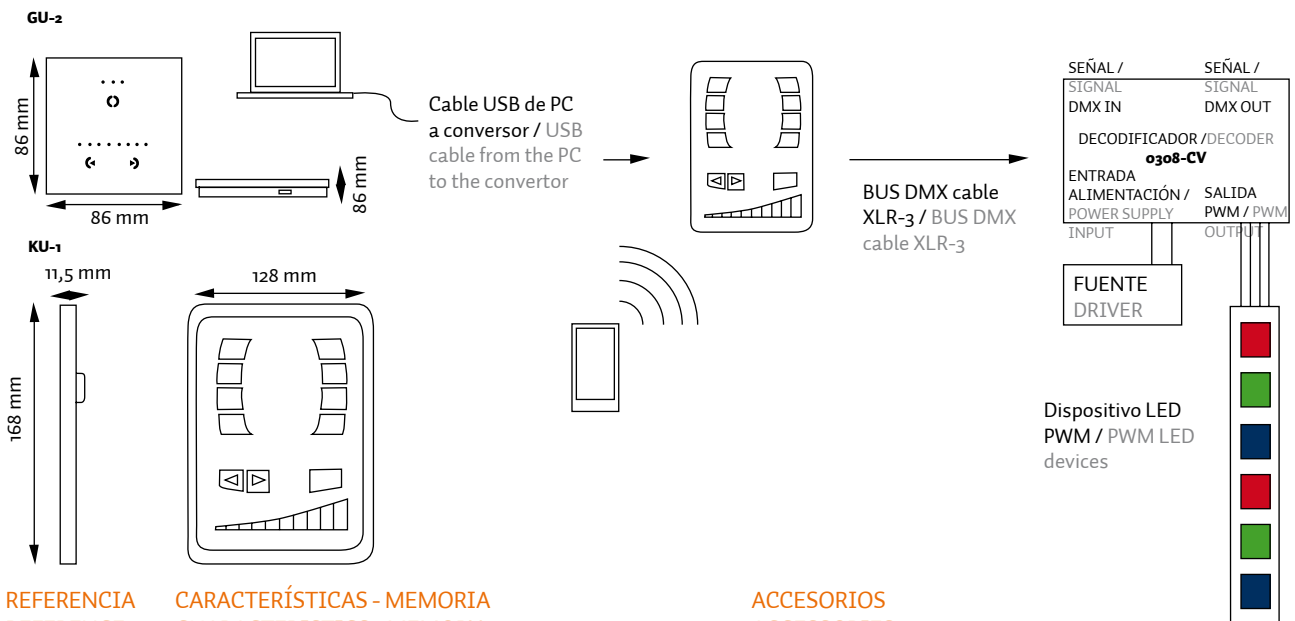

REFERENCIA
REFERENCE

CARACTERÍSTICAS - MEMORIA
CHARACTERISTICS - MEMORY

ACCESORIOS
ACCESSORIES

KU-1	Micro SD. 1024 canales. 200 escenas. 5 zonas / Micro SD. 1024 channels. 200 sequences. 5 zones	Cable, manual, drivers y programa / Wire, instructions, drivers and software
GU-2	5K. 128 canales. 24 escenas / 5K. 128 channels. 24 sequences	Cable, manual, drivers y programa / Wire, instructions, drivers and software
WI.KU-1	Accesorio para control por SmartPhone para KU-1 / Accessories to control via Smart phone for KU-1	Cable, manual, drivers y programa / Wire, instructions, drivers and software



71/

SENSORES DE PRESENCIA Y CONTACTO PRESENCE AND CONTACT SENSORS

Sensores de presencia y contacto para el encendido apagado de los equipos conectados a la salida.
Presence and contact sensors to switch ON and OFF the devices connected to the output.

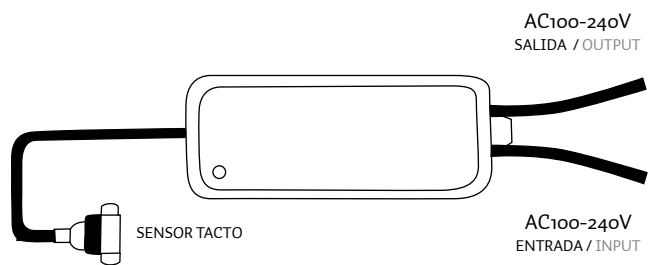
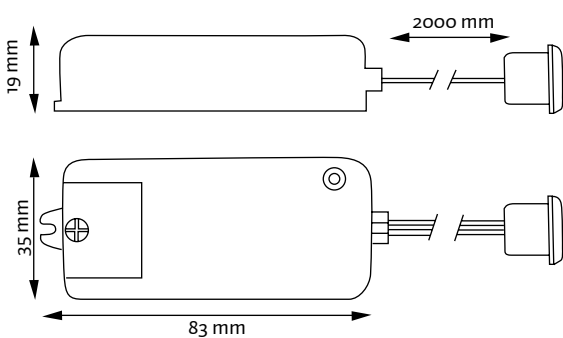

REFERENCIA REFERENCE	CARACTERÍSTICAS CHARACTERISTICS	POTENCIA MÁX MAX POWER	ENTRADA INPUT	DETECCIÓN DETECTION
HZKB250	Sensor de presencia PIR / Presence sensor PIR	250W	100-240V AC	2,50 mts
HZK218B	Sensor de presencia IR tipo pulsador (monoestable) / Presence sensor pushbutton model (monostable)	250W	100-240V AC	5-10 cm
HZK218C	Sensor de presencia IR tipo interruptor (biestable) / Presence sensor switch model (bistable)	250W	100-240V AC	5-10 cm
HZK201	Sensor de contacto / Contact sensor	250W	100-240V AC	Al tacto / touch

04

ILUMINACIÓN

EXTERIOR

OUTDOOR

LIGHTING



AP-NAS-1



AP-NAS-2

73 /

APLIQUE DE PARED SERIE NAS NAS WALL LAMP SERIE

Aplique de pared serie NAS con cuerpo fabricado en fundición de aluminio y pantalla de cristal. Fabricado con LED en blanco cálido pero con posibilidad de intercambiarlo por otra temperatura. Driver incluido para su funcionamiento a 230V AC.

NAS wall lamp serie aluminium smelter section and glass screen. Delivered with a warm White LED that can be change for other temperature. 230V AC driver included.



AP-NAS-1

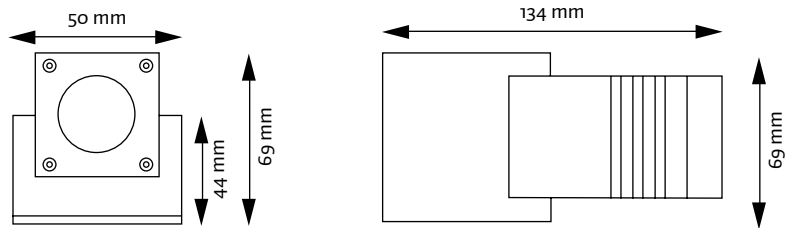

AP-NAS-2

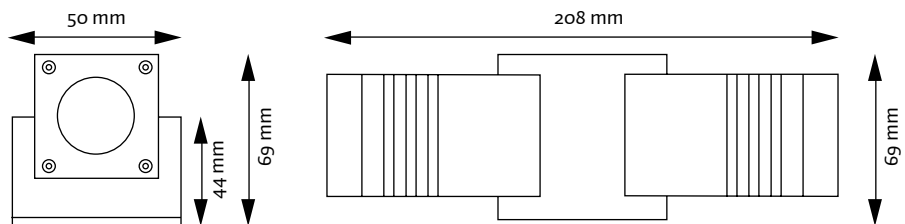

REFERENCIA REFERENCE	COLOR COLOR	TEMPERATURA TEMPERATURE	ALIMENTACIÓN POWER SUPPLY	PROTECCIÓN PROTECTION	TIPO DE LED LED TYPE
AP-NAS1	■	3000°	220-240V AC	IP44	1 LED 1W HP
AP-NAS2	■	3000°	220-240V AC	IP44	2 LED 1W HP



AP-TRES₁



AP-TRES₂



AP-TRES₃

74 /

APLIQUE DE PARED SERIE TRES TRES WALL LAMP SERIE

Aplique de pared serie TRES con cuerpo fabricado en fundición de aluminio y pantalla de cristal. Driver incluido para su funcionamiento a 230V AC.

TRES wall lamp serie with aluminium section and glass screen. 230V AC driver included.

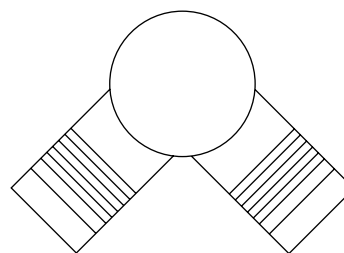
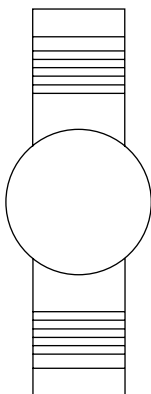
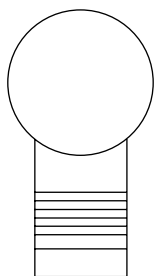
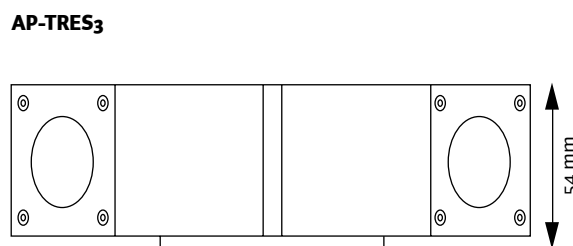
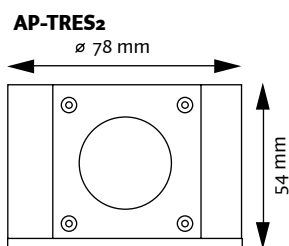
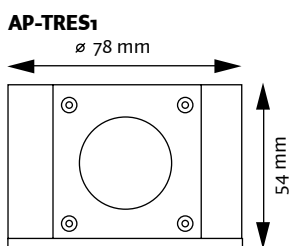

REFERENCIA REFERENCE	COLOR COLOR	TEMPERATURA TEMPERATURE	ALIMENTACIÓN POWER SUPPLY	PROTECCIÓN PROTECTION	TIPO DE LED LED TYPE
AP-TRES ₁	■	3000°	220-240V AC	IP44	1 LED 1W HP
AP-TRES ₂	■	3000°	220-240V AC	IP44	2 LED 1W HP
AP-TRES ₃	■	3000°	220-240V AC	IP44	2 LED 1W HP

75 /



JULIE-1



JULIE-2

APLIQUE DE PARED SERIE JULIE JULIE WALL LAMP SERIE

Aplique de pared serie JULIE con cuerpo fabricado en fundición de aluminio y pantalla de cristal. Driver incluido para su funcionamiento a 230V AC. Acabado en gris oscuro. Posibilidad de suministro en gris claro y en blanco.

JULIE wall lamp serie with aluminium section and glass screen. 230V AC driver included. Dark grey finish. Also available in light grey and white.



JULIE-1

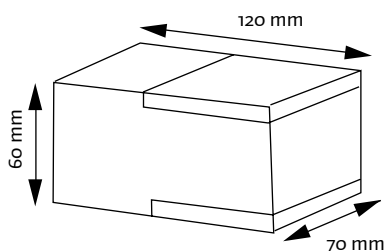

JULIE-2

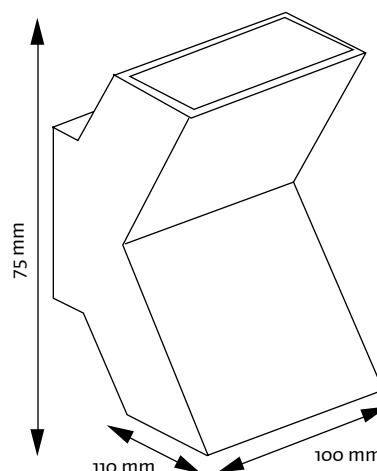

REFERENCIA REFERENCE	COLOR COLOR	TEMPERATURA TEMPERATURE	ALIMENTACIÓN POWER SUPPLY	PROTECCIÓN PROTECTION	TIPO DE LED LED TYPE	FLUJO LUM. LUM. FLOW	CONSUMO CONSUME
JULIE-1	■	3000°	220-240V AC	IP54	2 LED 3W HP	2x200lm	6W
JULIE-2	■	3000°	220-240V AC	IP54	2 LED 3W HP	2x200lm	6W



LONDRES-1



LONDRES-2



LONDRES-3-1000



LONDRES-1



LONDRES-3-400

76 /

ILUMINACIÓN SERIE LONDRES

LONDRES LIGHTING SERIE

Apliques y postes de iluminación serie LONDRES con cuerpo fabricado en fundición de aluminio y pantalla de cristal. Driver incluido para su funcionamiento a 230V AC. Acabado en gris oscuro. Posibilidad de suministro en gris claro y en blanco.

LONDRES wall lamp serie with glass screen and aluminium section. 230V AC driver included. Dark grey finish. Also available in light grey and white.

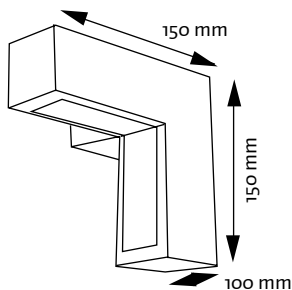

LONDRES-1

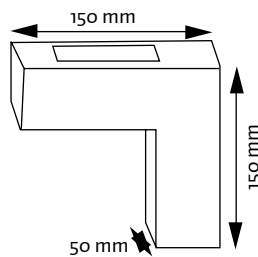

LONDRES-2

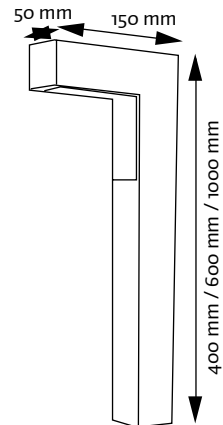

LONDRES-3

REFERENCIA REFERENCE	COLOR COLOR	TEMPERATURA TEMPERATURE	ALIMENTACIÓN POWER SUPPLY	PROTECCIÓN PROTECTION	TIPO DE LED LED TYPE	FLUJO LUM. LUM. FLOW	CONSUMO CONSUME
LONDRES-1		3000°	220-240V AC	IP54	2x16 LEDS 3528	150lm	3W
LONDRES-2		3000°	220-240V AC	IP54	2x16 LEDS 3528	150lm	3W
LONDRES-3-400		3000°	220-240V AC	IP54	2x16 LEDS 3528	150lm	3W
LONDRES-3-600		3000°	220-240V AC	IP54	2x16 LEDS 3528	150lm	3W
LONDRES-3-1000		3000°	220-240V AC	IP54	2x16 LEDS 3528	150lm	3W



PARÍS-1



PARÍS-2



PARÍS-3-600

77 /

ILUMINACIÓN SERIE PARIS

PARIS LIGHTING SERIE

Apliques y postes de iluminación serie PARIS con cuerpo fabricado en fundición de aluminio y pantalla de cristal. Driver incluido para su funcionamiento a 230V AC. Acabado en gris oscuro. Posibilidad de suministro en gris claro y en blanco.

PARIS wall lights and lamp series with cast aluminium section and glass screen. Driver included for operation at 230V AC. Finished in dark grey. Can be supplied in light grey and white.

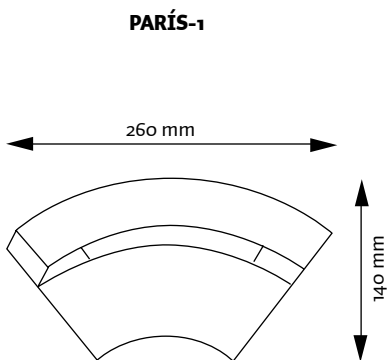

PARÍS-1

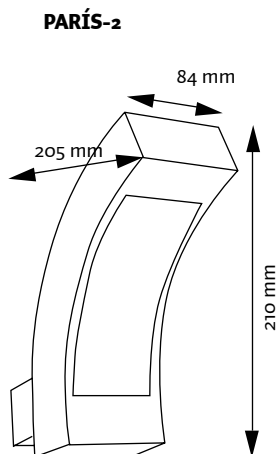

PARÍS-2

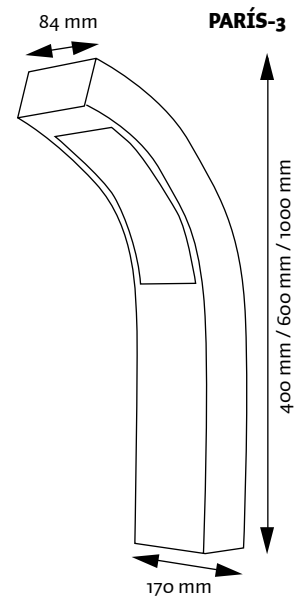

PARÍS-3

REFERENCIA REFERENCE	COLOR COLOR	TEMPERATURA TEMPERATURE	ALIMENTACIÓN POWER SUPPLY	PROTECCIÓN PROTECTION	TIPO DE LED LED TYPE	FLUJO LUM. LUM. FLOW	CONSUMO CONSUME
PARIS-1	■	3000°	220-240V AC	IP54	6 x 5 LEDS 5050	600lm	6W
PARIS-2	■	3000°	220-240V AC	IP54	6 x 5 LEDS 5050	600lm	6W
PARIS-3-400	■	3000°	220-240V AC	IP54	6 x 5 LEDS 5050	600lm	6W
PARIS-3-600	■	3000°	220-240V AC	IP54	6 x 5 LEDS 5050	600lm	6W
PARIS-3-1000	■	3000°	220-240V AC	IP54	6 x 5 LEDS 5050	600lm	6W



78 /

MINI EMPOTRABLES DE SEÑALIZACIÓN MINI RECESSED SIGNALING-LIGHTS

Luminarias empotrables para aplicaciones en suelo y pared ideal para iluminación decorativa y señalización de zona de pasos y escaleras. El modelo ME-43 está fabricado con frontal de acero 304 y cuerpo de aluminio. Los ME-KIT tanto blanco como RGB están fabricados con frontal de acero 316 y cuerpo de aluminio. Los KITS incluyen transformador con 2 mts de cable, cable de 10 mts con 6 conectores para cada luminaria y las 6 luminarias. El modelo RGB además incluye un receptor y mando a distancia IR.

Recessed lamps to be placed on the floor and on the wall; ideal for decorative lighting or to signal a path or a stair. The front part of the model ME-43 is in 304 stainless steel, aluminum section. The front part of the ME-Kit RGB and white are made in 316 stainless steel, aluminum section. The KITS enclose a transformer with 2 mts wire, 10 mts wire with 6 contactors for each lamp. The RGB model also includes a receiver and infra-red remote control.



ME-43

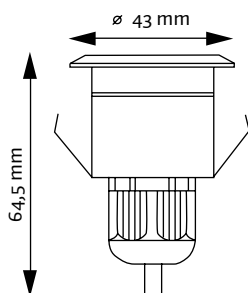

ME-KIT

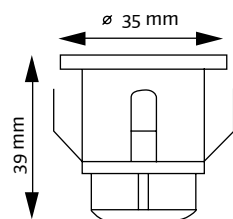

INSTALACIÓN-KIT / KIT INSTALATION

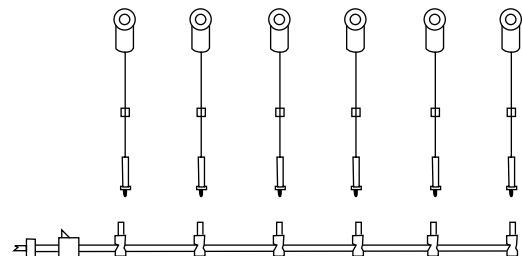

REFERENCIA REFERENCE	COLOR COLOR	ALIMENTACIÓN POWER SUPPLY	LED LED	PROTECCIÓN PROTECTION	CARACTERÍSTICAS CHARACTERISTICS
ME-43	White	220-240V AC	6 LEDs 0,1W	IP67	30cm de cable / wire
ME-KIT-B	White	12V transformador incluido 12V transformer included	6pcs x 6 LEDs 0,2W	IP67	Kit completo de 6 luminarias blanco Complete Kit of 6 white lights
ME-KIT-RGB	RGB	12V transformador incluido 12V transformer included	6pcs x 6 LEDs 0,1W	IP67	Kit completo de 6 luminarias RGB Complete kit of 6 RGB lights



EP1X3R

EP1X3C

EMPOTRABLE DE PARED RECESSED WALL

Empotrable de pared con haz de luz asimétrico para señalizaciones de pasillos, escaleras, etc. Fabricado en cuerpo de aluminio. Incluye carcasa empotrable para su instalación si se precisa. Color disponible en aluminio o blanco.

Recessed wall with asymmetrical light to signal of hallways, stairs, etc.. Made in aluminum section. Include recessed housing for installation if required. Color available in aluminum or white.



EP1X3R

EP1X3C

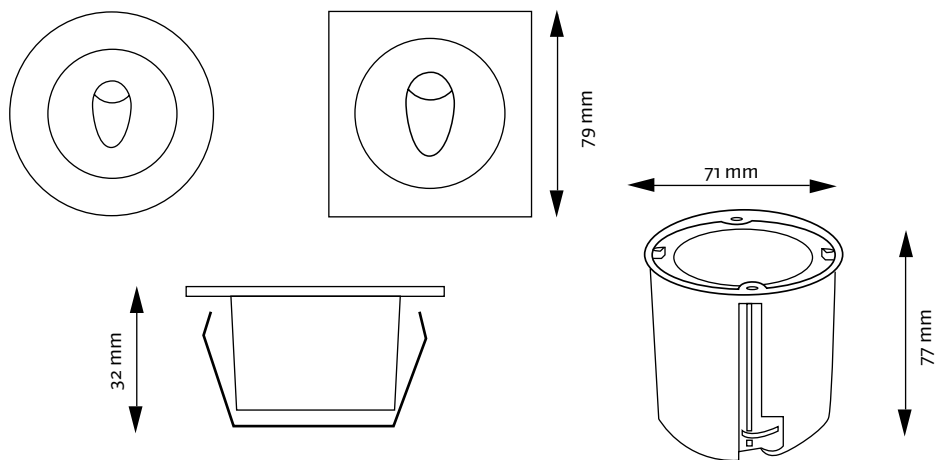

REFERENCIA REFERENCE	COLOR COLOR	TEMPERATURA TEMPERATURE	ALIMENTACIÓN POWER SUPPLY	PROTECCIÓN PROTECTION	TIPO DE LED LED TYPE	ÁNGULO ANGLE	CONSUMO CONSUME
EP-1X3R-BF	White	6000°K	220-240V AC	IP65	1x3W	80°	3,5W
EP-1X3R-BC	Yellow	3000°K	220-240V AC	IP65	1x3W	80°	3,5W
EP-1X3C-BF	White	6000°K	220-240V AC	IP65	1x3W	80°	3,5W
EP-1X3C-BC	Yellow	3000°K	220-240V AC	IP65	1x3W	80°	3,5W



EPR-2-BF

EPR-1-BF

EPR-3-BF

80 /

EMPOTRABLE DE PARED RECTANGULAR RECTANGULAR RECESSED WALL

Empotrable de pared rectangular para señalizaciones de pasillos y escaleras. Fabricado en cuerpo de aluminio. Incluye carcasa empotrable para su instalación si se precisa. Color disponible en aluminio.

Rectangular wall recessed to signal hallways and stairs. Made in aluminium section. Include recessed housing for installations if required. Color available in aluminium.



EPR-1-BF

EPR-2-BF

EPR-3-BF

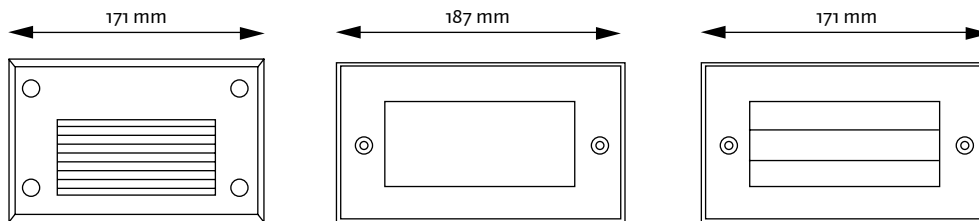

VISTA LATERAL
LATERAL VIEW

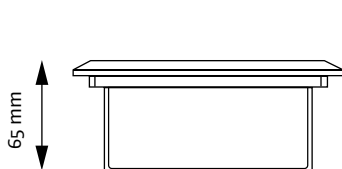

CARCARA DE MONTAJE
ASSEMBLY HOUSING

REFERENCIA REFERENCE	COLOR COLOR	TEMPERATURA TEMPERATURE	ALIMENTACIÓN POWER SUPPLY	PROTECCIÓN PROTECTION	TIPO DE LED LED TYPE	FLUJO LUM. LUM. FLOW	ÁNGULO ANGLE	CONSUMO CONSUME
EPR-1-BF	White	6000°K	220-240V AC	IP65	24 LEDS 3020	80lm	120°	8W
EPR-1-BC	Yellow	3000°K	220-240V AC	IP65	24 LEDS 3020	68lm	120°	8W
EPR-2-BF	White	6000°K	220-240V AC	IP65	28 LEDS 3020	48lm	120°	10W
EPR-2-BC	Yellow	3000°K	220-240V AC	IP65	28 LEDS 3020	41lm	120°	10W
EPR-3-BF	White	6000°K	220-240V AC	IP65	30 LEDS 3020	58lm	120°	12W
EPR-3-BC	Yellow	3000°K	220-240V AC	IP65	30 LEDS 3020	47lm	120°	12W



81 /

EMPOTRABLE DE SUELO 55mm RECESSED INGROUND 55mm

Empotrable de suelo de diámetro 55 mm con haz de luz simétrico o asimétrico. Fabricado con cuerpo y embellecedor de acero 316. Cristal templado de 8 mm. Incluye carcasa empotrable para su instalación si se precisa. Para el funcionamiento de los equipos RGB será preciso un controlador tipo CVRRGB.

Recessed inground with 55 mm diameter symmetrical or asymmetrical beam. Made with steel section and trim 316. 8 mm tempered glass. Includes recessed housing for installation if required. For RGB equipment will require a CVRRGB type controller.

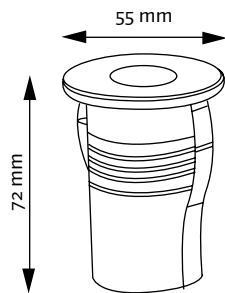

**ÁNGULO SIMÉTRICO
SYMETRIC ANGLE**

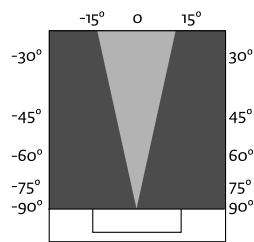

**ÁNGULO ASIMÉTRICO
ASYMETRIC ANGLE**

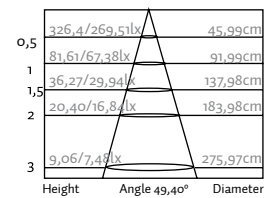
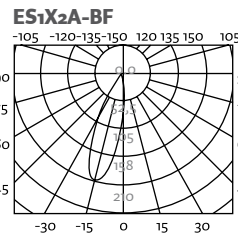
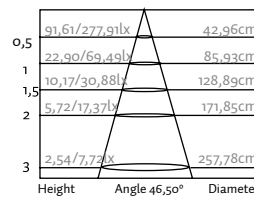
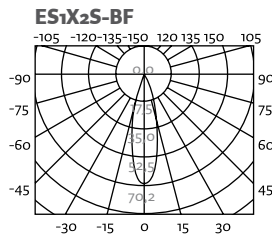
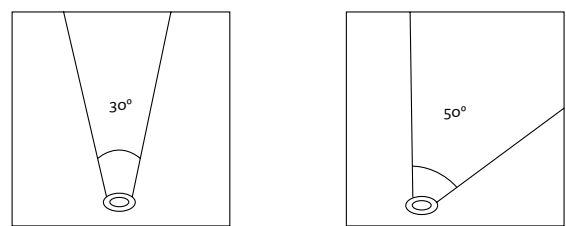

REFERENCIA REFERENCE	COLOR	TEMP. TEMP.	ALIMENTACIÓN POWER SUPPLY	PROTECCIÓN PROTECTION	TIPO DE LED LED TYPE	FLUJO LUM. LUM. FLOW	ÁNGULO ANGLE	CONSUMO CONSUME
ES1X2S-BF	White	6000°K	220-240V AC	IP67	1 LEDS 2W Cree	77lm	Symmetric 30°	4W
ES1X2S-BC	Yellow	3000°K	220-240V AC	IP67	1 LEDS 2W Cree	65lm	Symmetric 30°	4W
ES1X2S-RGB	RGB	RGB	24V DC	IP67	1 LEDS 2W Cree	R12/G29/B8	Symmetric 30°	5W
ES1X2A-BF	White	6000°K	220-240V AC	IP67	1 LEDS 2W Cree	77lm	Asymmetric 50-35°	4W
ES1X2A-BC	Yellow	3000°K	220-240V AC	IP67	1 LEDS 2W Cree	65lm	Asymmetric 50-35°	4W
ES1X2A-RGB	RGB	RGB	24V DC	IP67	1 LEDS 2W Cree	R12/G29/B8	Asymmetric 50-35°	5W



82 /

EMPOTRABLE DE SUELO 116MM RECESSED INGROUND 116MM

Empotrable de suelo de diámetro 116mm con haz de luz simétrico o asimétrico. Fabricado con cuerpo y embellecedor de acero 316. Cristal templado de 8mm. Incluye carcasa empotrable para su instalación si se precisa. Para el funcionamiento de los equipos RGB será preciso un controlador tipo CVRRGB.

Recessed inground with 116mm diameter symmetrical or asymmetrical beam. Made with steel section and trim 316. 8mm tempered glass. Includes recessed housing for installation if required. For RGB equipment will require a CVRRGB type controller.

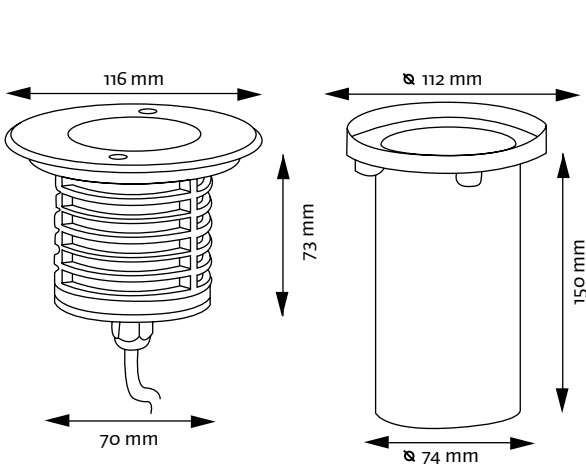

ES3x2S-BF

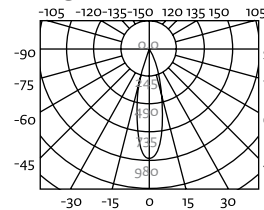

0,5	309,1/1027lx	53,28cm
1	77,28/256,7lx	106,57cm
1,5	34,34/114lx	159,85cm
2	19,32/64,18lx	213,13cm
3	8,58/28,52lx	319,70cm
Height		Angle 56,10° Diameter

ES3x2S-BC

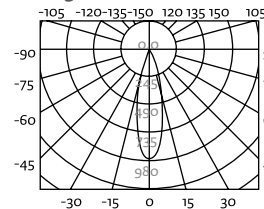

0,5	1422/3881lx	33,56cm
1	355,3/970,3lx	67,11cm
1,5	157,9/431,2lx	100,67cm
2	88,84/242,6lx	134,23cm
3	39,48/107,8lx	201,34cm
Height		Angle 37,10° Diameter

REFERENCIA REFERENCE	COLOR COLOR	TEMP. TEMP.	ALIMENTACIÓN POWER SUPPLY	PROTECCIÓN PROTECTION	TIPO DE LED LED TYPE	FLUJO LUM. LUM. FLOW	ÁNGULO ANGLE	CONSUMO CONSUME
ES3X2S-BF	White	6000°K	220-240V AC	IP67	3 LEDs 2W Cree	347lm	Symmetric 22°	8W
ES3X2S-BC	Yellow	3000°K	220-240V AC	IP67	3 LEDs 2W Cree	300lm	Symmetric 22°	8W
ES3X2S-RGB	RGB	RGB	24V DC	IP67	3 LEDs 2W Cree	R48/G79/B20	Symmetric 20°	10W
ES3X2A-BF	White	6000°K	220-240V AC	IP67	3 LEDs 2W Cree	338lm	Asymmetric 45-35°	8W
ES3X2A-BC	Yellow	3000°K	220-240V AC	IP67	3 LEDs 2W Cree	286lm	Asymmetric 45-35°	8W
ES3X2A-RGB	RGB	RGB	24V DC	IP67	3 LEDs 2W Cree	R48/G79/B20	Asymmetric 50-35°	10W



83 /

EMPOTRABLE DE SUELO 173MM RECESSED INGROUND 173MM

Empotrable de suelo de diámetro 116mm con haz de luz simétrico o asimétrico. Fabricado con cuerpo y embellecedor de acero 316. Cristal templado de 8mm. Incluye carcasa empotrable para su instalación si se precisa. Para el funcionamiento de los equipos RGB será preciso un controlador tipo CVRRGB.

Recessed inground with 173mm diameter symmetrical or asymmetrical beam. Made with steel section and trim 316. 8mm tempered glass. Includes recessed housing for installation if required. For RGB equipment will require a CVRRGB type controller.

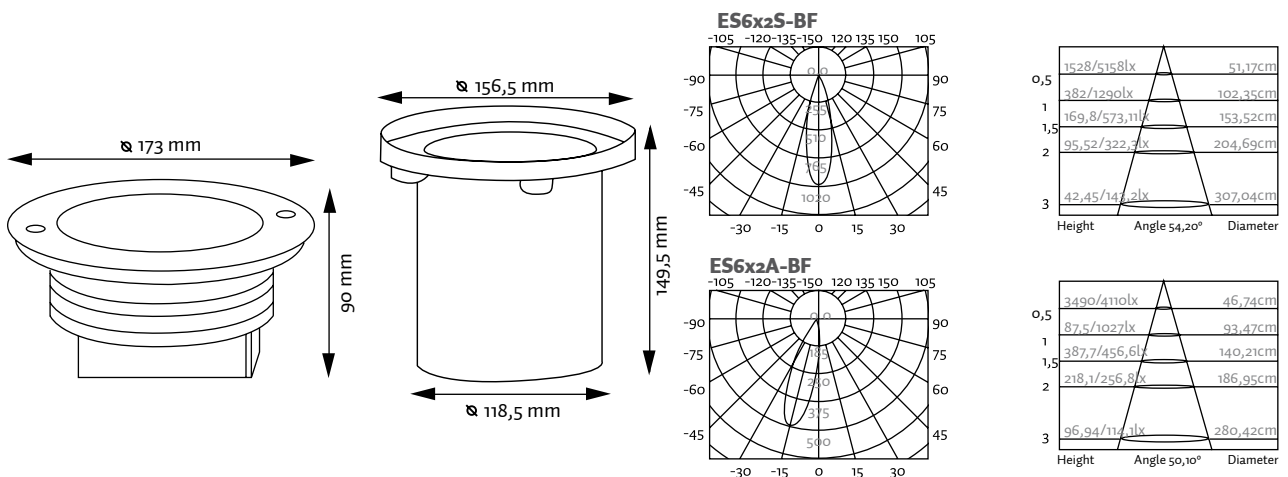

REFERENCIA	COLOR	TEMP.	ALIMENTACIÓN	PROTECCIÓN	TIPO DE LED	FLUJO LUM.	ÁNGULO	CONSUMO
REFERENCE	COLOR	TEMP.	POWER SUPPLY	PROTECTION	LED TYPE	LUM. FLOW	ANGLE	CONSUME
ES6X2S-BF	White	6000°K	220-240V AC	IP67	6 LEDs 2W Cree	528lm	Symmetric 20°	8W
ES6X2S-BC	Yellow	3000°K	220-240V AC	IP67	6 LEDs 2W Cree	455lm	Symmetric 20°	8W
ES6X2S-RGB	RGB	RGB	24V DC	IP67	6 LEDs 2W Cree	R100/G155/B45	Symmetric 20°	10W
ES6X2A-BF	White	6000°K	220-240V AC	IP67	6 LEDs 2W Cree	590lm	Asymmetric 45-35°	8W
ES6X2A-BC	Yellow	3000°K	220-240V AC	IP67	6 LEDs 2W Cree	510lm	Asymmetric 45-35°	8W
ES6X2A-RGB	RGB	RGB	24V DC	IP67	6 LEDs 2W Cree	R100/G155/B45	Asymmetric 50-35°	10W



84 /

BAÑADOR DE PARED WALL WASHER

Bañador de pared de 500 y 1000mm de longitud de 18 y 36 LEDS respectivamente. Carcasa de aluminio de alto impacto con estanqueidad IP65 para su aplicación en exteriores para iluminar fachadas. Incluye escuadras de fijación a pared.

Para el funcionamiento de los equipos RGB será preciso un controlador tipo CVRRGB.

Wall washer 500 and 1000mm in length from 18 and 36 LEDS respectively. Aluminum housing with high impact IP65 for outdoor use to illuminate facades. Include wall mounting brackets. RGB (4 wire) control will require CVRRGB driver.

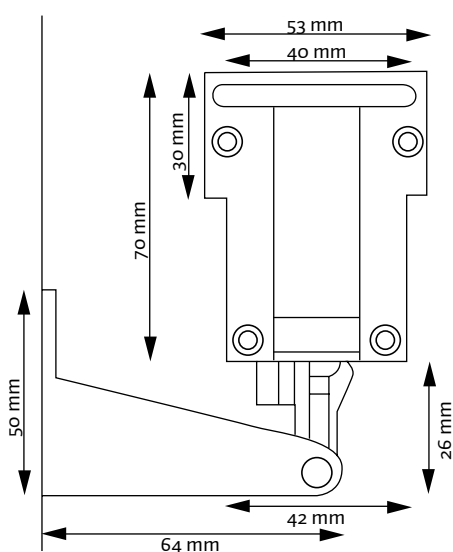

REFERENCIA REFERENCE	COLOR COLOR	TEMP. TEMP.	ALIMENTACIÓN POWER SUPPLY	MEDIDAS DIMENSIONS	TIPO DE LED LED TYPE	FLUJO LUM. LUM. FLOW	ÁNGULO ANGLE	CONSUMO CONSUME
BP500B		6000°K	24V DC	500x53x70mm	18 LEDS iWHP	1600lm	25-45°	24W
BP1000B		6000°K	24V DC	1000x53x70mm	36 LEDS iWHP	3200lm	25-45°	48W
BP500RGB		RGB	24V DC	500x53x70mm	18 LEDS iWHP	R375/G580/B175	25-45°	24W
BP1000RGB		RGB	24V DC	1000x53x70mm	36 LEDS iWHP	R750/G1160/B350	25-45°	48W



PIQUETAS DE JARDÍN GARDEN SPIKES

Piquetas de exterior fabricado en aluminio con acabado anodizado. Montada con óptica en ángulo de 22-30°. Para el funcionamiento de los equipos RGB será preciso un controlador tipo CVRRGB. /Outer spikes made in aluminum with anodized finish. Mounted with optical angle of 30°. For RGB equipment will require a CVRRGB type controller.



PQ1X3

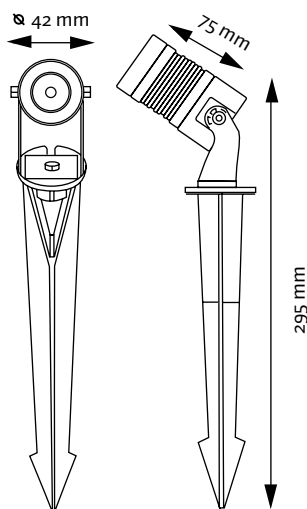

PQ3X2

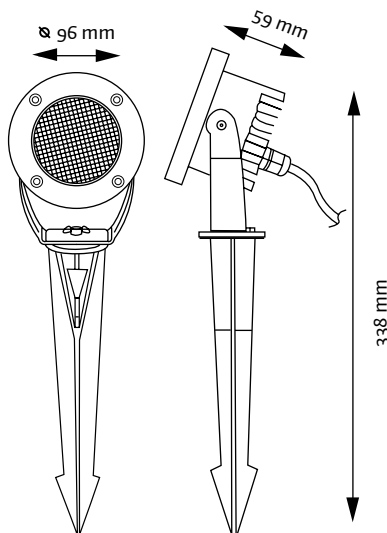

PQ1X3-BF

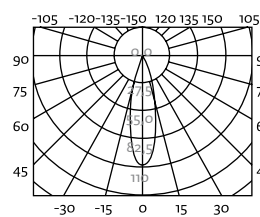

Height	Angle 48,80°	Diameter
0,5	141,2/429,4lx	45,36cm
1	35,31/107,3lx	90,72cm
1,5	15,69/43,7lx	136,09cm
2	8,828/26,8lx	181,45cm
3	3,933/11,82lx	272,17cm

PQ3X2-BF

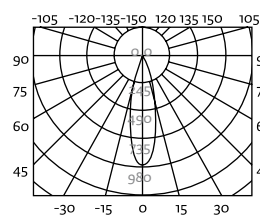

Height	Angle 56,10°	Diameter
0,5	309,1/1027lx	53,28cm
1	77,28/256,7lx	106,57cm
1,5	34,34/114,0lx	159,85cm
2	19,32/64,18lx	213,13cm
3	8,58/28,72lx	319,70cm

REFERENCIA REFERENCE	COLOR COLOR	TEMP. TEMP.	ALIMENTACIÓN POWER SUPPLY	PROTECCIÓN PROTECTION	TIPO DE LED LED TYPE	FLUJO LUM. LUM. FLOW	ÁNGULO ANGLE	CONSUMO CONSUME
PQ1X3-BF	White	6000°K	220-240V AC	IP65	1 LEDS 3W	95lm	Symmetric 30°	4W
PQ1X3-BC	Yellow	3000°K	220-240V AC	IP65	1 LEDS 3W	81lm	Symmetric 30°	4W
PQ1X3-RGB	RGB	RGB	24V DC	IP65	1 LEDS 3W	R18/G26/B6	Symmetric 30°	5W
PQ3X2-BF	White	6000°K	220-240V AC	IP65	3 LEDS 2W	224lm	Symmetric 22°	8W
PQ3X2-BC	Yellow	3000°K	220-240V AC	IP65	3 LEDS 2W	198lm	Symmetric 22°	8W
PQ3X2-RGB	RGB	RGB	24V DC	IP65	3 LEDS 2W	R70/G113/B31	Symmetric 20°	12W



PROYECTORES DE JARDÍN GARDEN SPOTLIGHT

Pequeños proyectores de exterior fabricados en aluminio con acabado anodizado. Montada con óptica en ángulo de 30°. Para el funcionamiento de los equipos RGB será preciso un controlador tipo CVRRGB. / Small outdoor spotlight made of anodized aluminum. Mounted with optical angle of 30°. RGB (4 wire) control will require CVRRGB driver.

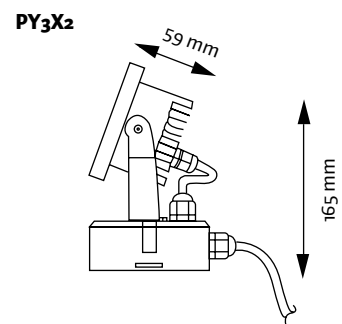
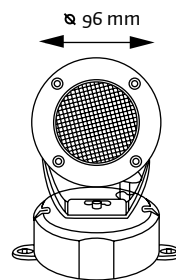
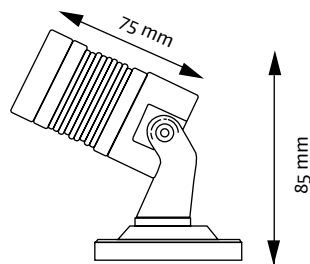
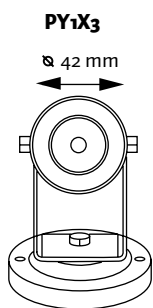

PY1X3-BF

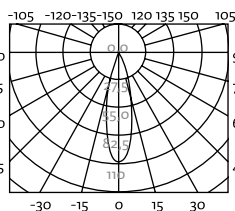

Height	Angle 48,80°	Diameter
0,5	141,2/429,4lx	45,26cm
1	35,31/107,3lx	90,72cm
1,5	15,69/43,71lx	136,09cm
2	8,828/26,8lx	181,45cm
3	3,933/11,92lx	272,17cm

PY3X2-BF

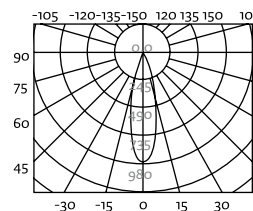

Height	Angle 56,10°	Diameter
0,5	309,1/1027lx	53,28cm
1	77,28/256,7lx	106,57cm
1,5	34,34/114,0lx	159,85cm
2	19,32/64,18lx	213,13cm
3	8,58/28,52lx	319,70cm

REFERENCIA REFERENCE	COLOR COLOR	TEMP. TEMP.	ALIMENTACIÓN POWER SUPPLY	PROTECCIÓN PROTECTION	TIPO DE LED LED TYPE	FLUJO LUM. LUM. FLOW	ÁNGULO ANGLE	CONSUMO CONSUME
PY1X3-BF	White	6000°K	220-240V AC	IP65	1 LEDS 3W	95lm	Symmetric 30°	4W
PY1X3-BC	Yellow	3000°K	220-240V AC	IP65	1 LEDS 3W	81lm	Symmetric 30°	4W
PY1X3-RGB	RGB	RGB	24V DC	IP65	1 LEDS 3W	R18/G26/B6	Symmetric 30°	5W
PY3X2-BF	White	6000°K	220-240V AC	IP65	3 LEDS 2W	224lm	Symmetric 22°	8W
PY3X2-BC	Yellow	3000°K	220-240V AC	IP65	3 LEDS 2W	198lm	Symmetric 22°	8W
PY3X2-RGB	RGB	RGB	24V DC	IP65	3 LEDS 2W	R70/G113/B31	Symmetric 20°	12W



87 /

PROYECTORES DE JARDÍN ALTA POTENCIA

HIGH POWER OUTDOOR SPOTLIGHT

Proyectores de exterior de alta potencia fabricados en aluminio con acabado anodizado. Montada con óptica en ángulo desde 6° a 30°. Para el funcionamiento de los equipos RGB será preciso un controlador tipo CVRRGB.

High power outdoor floodlight made of aluminum with anodized finish. Mounted with optical angle from 6° to 30°. RGB (4 wire) control will require CVRRGB driver.



PY6X2

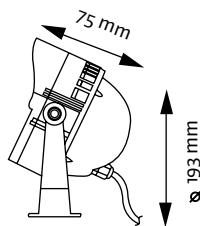
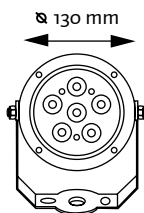

PY12X2

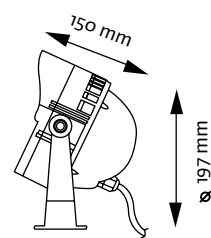
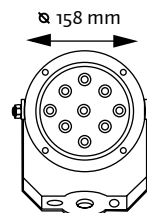

PY6X2-BF

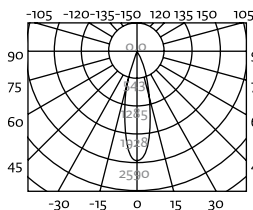

0,5	679,9/2629lx	55,43cm
1	169,9/657,2lx	110,86cm
1,5	75,54/292,1lx	166,29cm
2	42,49/164,3lx	221,72cm
3	18,88/73,22lx	332,59cm

Height Angle 58,00° Diameter

PY12X2

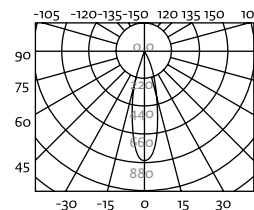

0,5	1076/3472lx	53,28cm
1	168,9/868,0lx	106,57cm
1,5	119,5/385,8lx	159,85cm
2	67,24/227,0lx	213,13cm
3	29,88/96,45lx	319,70cm

Height Angle 56,10° Diameter

REFERENCIA REFERENCE	COLOR COLOR	TEMP. TEMP.	ALIMENTACIÓN POWER SUPPLY	PROTECCIÓN PROTECTION	TIPO DE LED LED TYPE	FLUJO LUM. LUM. FLOW	ÁNGULO ANGLE	CONSUMO CONSUME
PY6X2-BF	White	6000°K	220-240V AC	IP65	6 LEDS2W	605lm	6°-13°-20°-30°	15W
PY6X2-BC	Yellow	3000°K	220-240V AC	IP65	6 LEDS 2W	525lm	6°-13°-20°-30°	15W
PY6X2-RGB	RGB	RGB	24V DC	IP65	6 LEDS 2W	R100/G155/B20	15°-30°	15W
PY12X2-BF	White	6000°K	220-240V AC	IP65	12 LEDS 2W	950lm	6°-13°-20°-30°	30W
PY12X2-BC	Yellow	3000°K	220-240V AC	IP65	12 LEDS 2W	810lm	6°-13°-20°-30°	30W
PY12X2-RGB	RGB	RGB	24V DC	IP65	12 LEDS 2W	R210/G315/B92	15°-30°	30W



88 /

PROYECTORES SUMERGIBLES WATERPROOF SPOTLIGHT

Proyector sumergible IP68 fabricado completamente en acero 316. Montado con óptica en ángulo de 15° para colores blancos y 25° para RGB. Para el funcionamiento de los equipos RGB será preciso un controlador tipo CVRRGB.

IP68 stainless steel 316 waterproof spotlight. Mounted with optical angle of 15° to 25°, for white and RGB. RGB (4 wire) control will require CVRRGB driver.

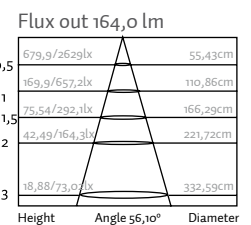
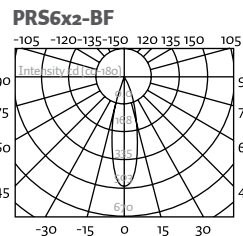
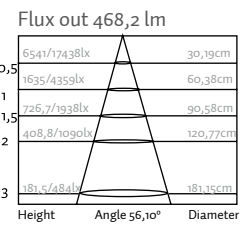
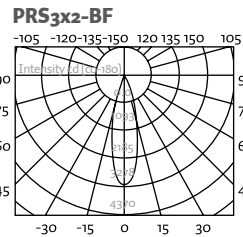
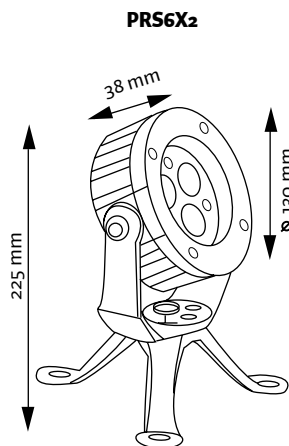
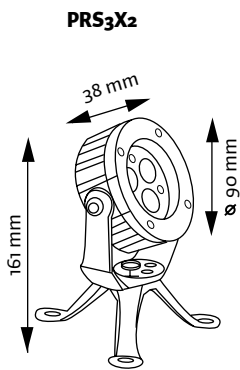

REFERENCIA REFERENCE	COLOR COLOR	TEMP. TEMP.	ALIMENTACIÓN POWER SUPPLY	PROTECCIÓN PROTECTION	TIPO DE LED LED TYPE	FLUJO LUM. LUM. FLOW	ÁNGULO ANGLE	CONSUMO CONSUME
PRS3X2-BF	White	6000°K	24V DC	IP68	3 LEDs 2W	321lm	Symmetric 15°	8W
PRS3X2-BC	Yellow	3000°K	24V DC	IP68	3 LEDs 2W	274lm	Symmetric 15°	8W
PRS3X2-RGB	RGB	RGB	24V DC	IP68	3 LEDs 2W	R48/G79/B20	Symmetric 25°	10W
PRS6X2-BF	White	6000°K	24V DC	IP68	6 LEDs 2W	600lm	Symmetric 15°	14W
PRS6X2-BC	Yellow	3000°K	24V DC	IP68	6 LEDs 2W	520lm	Symmetric 15°	14W
PRS6X2-RGB	RGB	RGB	24V DC	IP68	6 LEDs 2W	R100/G155/B45	Symmetric 25°	16W



89 /

EMPOTRABLE SUMERGIBLE 67mm WATERPROOF RECESSED 67mm

Empotrable sumergible de diámetro 67,5mm con haz de luz simétrico o asimétrico. Fabricado con cuerpo y embellecedor de acero 316. Cristal templado de 8mm. Incluye nicho empotrable para su instalación. Para el funcionamiento de los equipos RGB (4 cables) será preciso un controlador tipo CVRRGB. Instalación ideal para piscinas, estanques...

Waterproof recessed 67,5mm diameter with symmetrical or asymmetrical light beam. Made with steel section 316. 8mm tempered glass. Installation recessed enclosed. For RGB (4 wire) equipment will require CVRRGB controller type. Ideal for pools, ponds ...

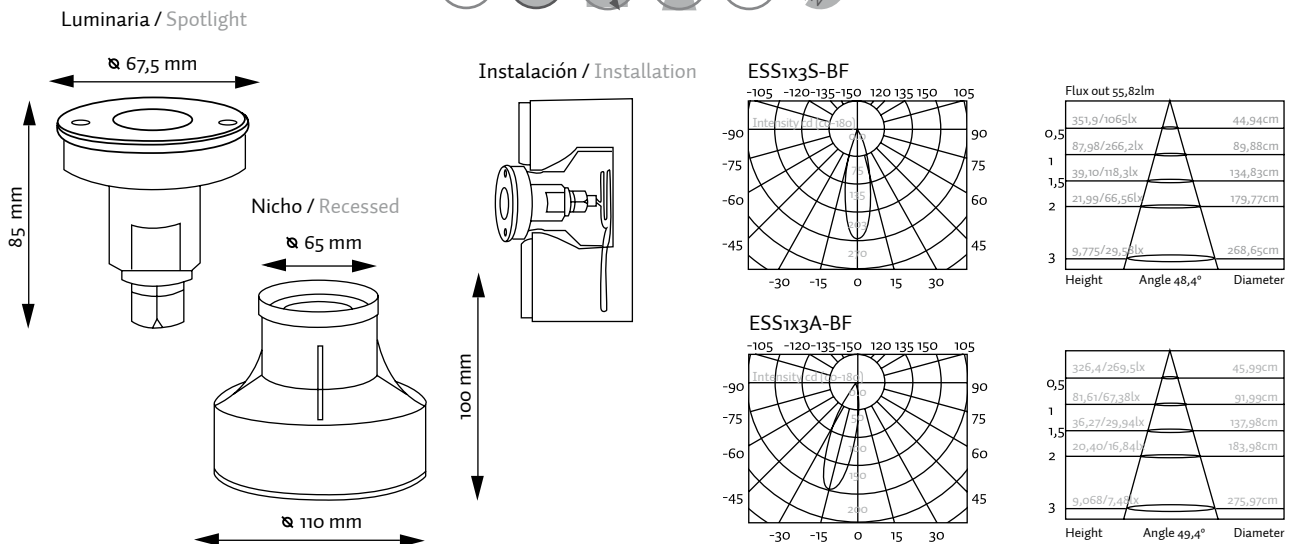

REFERENCIA REFERENCE	COLOR COLOR	TEMP. TEMP.	ALIMENTACIÓN POWER SUPPLY	PROTECCIÓN PROTECTION	TIPO DE LED LED TYPE	FLUJO LUM. LUM. FLOW	ÁNGULO ANGLE	CONSUMO CONSUME
ESS1X3S-BF	White	6000°K	24V DC	IP68	1 LEDS 3W	67lm	Symmetric 30°	5W
ESS1X3S-BC	Yellow	3000°K	24V DC	IP68	1 LEDS 3W	57lm	Symmetric 30°	5W
ESS1X3S-RGB	RGB	RGB	24V DC	IP68	1 LEDS 3W	R17/G30/B9lm	Symmetric 30°	6W
ESS1X3A-BF	White	6000°K	24V DC	IP68	1 LEDS 3W	68lm	Asymmetric 50-35°	5W
ESS1X3A-BC	Yellow	3000°K	24V DC	IP68	1 LEDS 3W	62lm	Asymmetric 50-35°	5W
ESS1X3A-RGB	RGB	RGB	24V DC	IP68	1 LEDS 3W	R23/G33/B11lm	Asymmetric 50-35°	6W



90 /

EMPOTRABLE SUMERGIBLE 150mm WATERPROOF RECESSED 150mm

Empotrable sumergible de diámetro 150mm con haz de luz simétrico o asimétrico. Fabricado con cuerpo y embellecedor de acero 316. Cristal templado de 8mm. Incluye nicho empotrable para su instalación. Para el funcionamiento de los equipos RGB (4 cables) será preciso un controlador tipo CVRRGB. Instalación ideal para piscinas, estanques...

Waterproof recessed 150mm diameter light beam is symmetrical or asymmetrical. Made with stainless steel section 316. 8mm tempered glass. Installation recessed enclosed. RGB (4-wire) control will require CVRRGB driver. Ideal for pools, ponds ...



Luminaria / Spotlight

Nicho / Recessed

Instalación / Installation

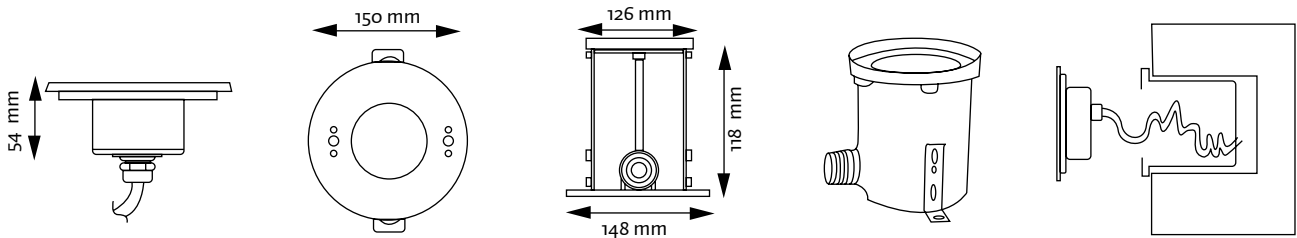

ESS3x3S-BF

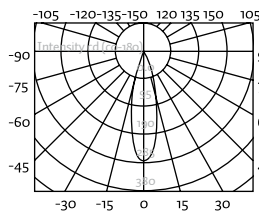

Height	Angle 50,40°	Diameter
0,5	549,8/1699lx	47,06cm
1	137,4/424,6lx	94,11cm
1,5	61,09/188,7lx	141,17cm
2	34,36/106,1lx	188,23cm
3	15,27/47,18lx	282,34cm

ESS3x3A-BF

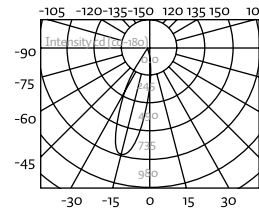

Height	Angle 50,40°	Diameter
0,5	472,7/1497lx	47,91cm
1	118,1/374lx	95,82cm
1,5	52,53/166,3lx	143,74cm
2	29,54/93,5lx	191,65cm
3	13,13/41,57lx	287,47cm

REFERENCIA REFERENCE	COLOR COLOR	TEMP. TEMP.	ALIMENTACIÓN POWER SUPPLY	PROTECCIÓN PROTECTION	TIPO DE LED LED TYPE	FLUJO LUM. LUM. FLOW	ÁNGULO ANGLE	CONSUMO CONSUME
ESS3X3S-BF	White	6000°K	24V DC	IP68	3 LEDs 3W	310lm	Symmetric 30°	10W
ESS3X3S-BC	Yellow	3000°K	24V DC	IP68	3 LEDs 3W	270lm	Symmetric 30°	10W
ESS3X3S-RGB	RGB	RGB	24V DC	IP68	3 LEDs 3W	R71/G108/B35	Symmetric 30°	12W
ESS3X3A-BF	White	6000°K	24V DC	IP68	3 LEDs 3W	330lm	Asymmetric 50-35°	10W
ESS3X3A-BC	Yellow	3000°K	24V DC	IP68	3 LEDs 3W	290lm	Asymmetric 50-35°	10W
ESS3X3A-RGB	RGB	RGB	24V DC	IP68	3 LEDs 3W	R75/G116/B35	Asymmetric 50-35°	12W



91 /

EMPOTRABLE SUMERGIBLE 180mm WATERPROOF RECESSED 180mm

Empotrable sumergible de diámetro 180mm con haz de luz simétrico o asimétrico. Fabricado con cuerpo y embellecedor de acero 316. Cristal templado de 8mm. Incluye nicho empotrable para su instalación. Para el funcionamiento de los equipos RGB (4 cables) será preciso un controlador tipo CVRRGB. Instalación ideal para piscinas, estanques...

Waterproof recessed 180mm diameter light beam is symmetrical or asymmetrical. Made with steel section 316. 8mm tempered glass. Installation recessed enclosed. RGB (4 wire) control will require CVRRGB driver. Ideal for pools, ponds...



Luminaria / Spotlight

Nicho / Recessed

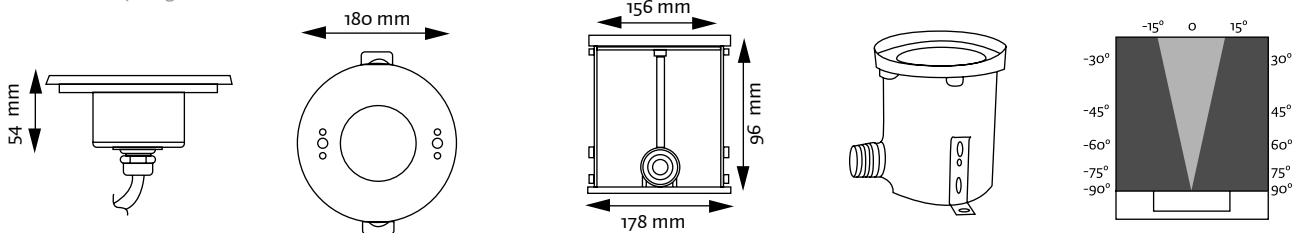

ESS6x3S-BF

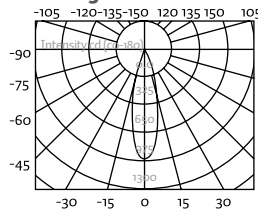

Height	Intensity (lx)	Diameter
0,5	1528/5158lx	51,17cm
1	383/1290lx	102,35cm
1,5	169,8/573,11lx	153,52cm
2	95,52/322,31lx	204,69cm
3	42,45/143,71lx	307,04cm

ESS6x3A-BF

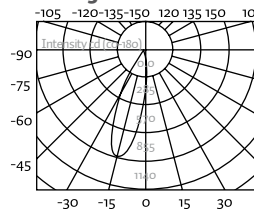

Height	Intensity (lx)	Diameter
0,5	515,7/1018lx	56,81cm
1	128,9/254,3lx	113,62cm
1,5	57,30/113lx	170,42cm
2	32,23/63,59lx	227,23cm
3	14,32/28,25lx	340,85cm

REFERENCIA	COLOR	TEMP.	ALIMENTACIÓN	PROTECCIÓN	TIPO DE LED	FLUJO LUM.	ÁNGULO	CONSUMO
REFERENCE	COLOR	TEMP.	POWER SUPPLY	PROTECTION	LED TYPE	LUM. FLOW	ANGLE	CONSUME
ESS6X3S-BF	White	6000°K	24V DC	IP68	6 LEDS 3W	545lm	Symmetric 30°	20W
ESS6X3S-BC	Yellow	3000°K	24V DC	IP68	6 LEDS 3W	490lm	Symmetric 30°	20W
ESS6X3S-RGB	RGB	RGB	24V DC	IP68	6 LEDS 3W	R131/G255/B60	Symmetric 30°	25W
ESS6X3A-BF	White	6000°K	24V DC	IP68	6 LEDS 3W	549lm	Asymmetric 50-35°	20W
ESS6X3A-BC	Yellow	3000°K	24V DC	IP68	6 LEDS 3W	495lm	Asymmetric 50-35°	20W
ESS6X3A-RGB	RGB	RGB	24V DC	IP68	6 LEDS 3W	R136/G258/B63	Asymmetric 50-35°	25W



92 /

EMPOTRABLE SUMERGIBLE RECTANGULAR WATERPROOF RECESSED RECTANGULAR

Empotrable sumergible rectangular con haz de luz simétrico o asimétrico. Fabricado con cuerpo y embellecedor de acero 316. Cristal templado de 8mm. Incluye nicho empotrable para su instalación. Para el funcionamiento de los equipos RGB (4 cables) será preciso un controlador tipo CVRRGB. Instalación ideal para piscinas, estanques...

Waterproof recessed rectangular beam symmetrical or asymmetrical. Made with steel body 316. 8mm tempered glass. Installation recessed enclosed. RGB (4-wire) control will require CVRRGB driver. Ideal for pools, ponds ...



Luminaria / Spotlight

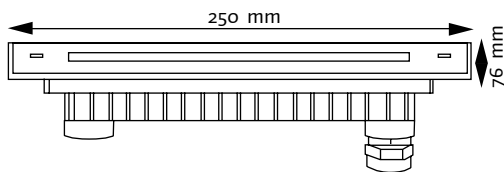

Nicho / Recessed

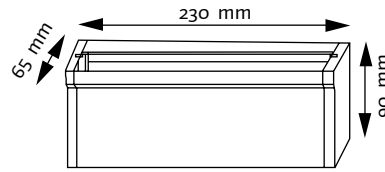

ESR6x2S-BC

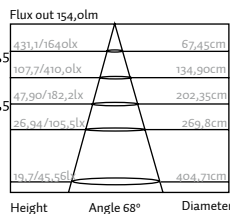
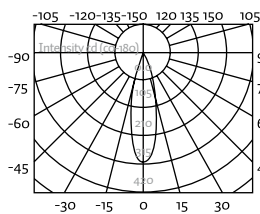

ESR6x2A-BF

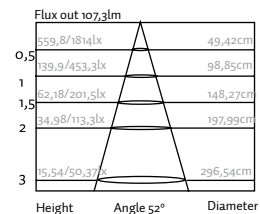
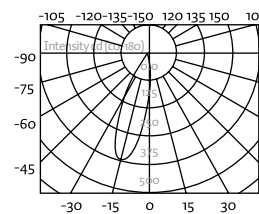

REFERENCIA REFERENCE	COLOR COLOR	TEMP. TEMP.	ALIMENTACIÓN POWER SUPPLY	PROTECCIÓN PROTECTION	TIPO DE LED LED TYPE	FLUJO LUM. LUM. FLOW	ÁNGULO ANGLE	CONSUMO CONSUME
ESR6X2S-BF	White	6000°K	24V DC	IP68	6 LEDs 2W	605lm	Symmetric 30°	15W
ESR6X2S-BC	Yellow	3000°K	24V DC	IP68	6 LEDs 2W	520lm	Symmetric 30°	15W
ESR6X2S-RGB	RGB	RGB	24V DC	IP68	6 LEDs 2W	R79/G166/B43	Symmetric 30°	20W
ESR6X2A-BF	White	6000°K	24V DC	IP68	6 LEDs 2W	610lm	Asymmetric 50-35°	15W
ESR6X2A-BC	Yellow	3000°K	24V DC	IP68	6 LEDs 2W	525lm	Asymmetric 50-35°	15W
ESR6X2A-RGB	RGB	RGB	24V DC	IP68	6 LEDs 2W	R83/G170/B45	Asymmetric 50-35°	20W



93 /

MINI PROYECTORES PARA PISCINA MINI SPOTLIGHT FOR SWIMMING POOL

Mini proyectores LED en blanco o RGB para empotrar. Protección IP68. Cable incluido. El mini proyector RGB incluye una secuencia de colores para generar hasta 15 escenas diferentes.

Mini recessed RGB or White LED spotlights. IP68 protection. Wire enclosed. The mini RGB spotlight can create until 15 different color sequences.



FOMINI/PA17883

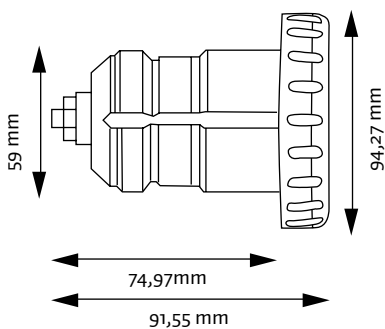

POMINI/PA17885

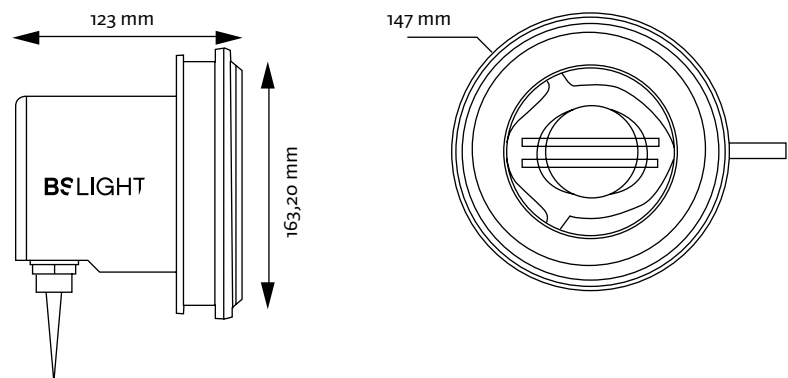

REFERENCIA REFERENCE	COLOR COLOR	TIPO LED LED TYPE	ALIMENTACIÓN POWER SUPPLY	FLUJO LUM. LUM. FLOW	POTENCIA POWER	CONTROL CONTROL
POMINIB	White	18 LEDS 5mm	12V AC	54,7lm	2W	Cables / Wires
POMINIRGB	RGB	18 LEDS 5mm	12V AC	24,25lm	2W	Cables / Wires
FOMINIB	White	18 LEDS 5mm	12V AC	54,7lm	2W	Cables / Wires
FOMINIRGB	RGB	18 LEDS 5mm	12V AC	24,25lm	2W	Cables / Wires
PA17885	Yellow	Halógena/Halogen	12V AC	245lm	50W	Cables / Wires
PA17883	Yellow	Halógena/Halogen	12V AC	245lm	50W	Cables / Wires



94 /

PROYECTORES PARA PISCINA SWIMMING POOL SPOTLIGHTS

Proyectores planos y de empotrar para piscinas de obra. Incluye todos los accesorios de instalación y funcionamiento. El modelo PO300W incluye una bombilla halógena que podrá ser reemplazada por una bombilla PAR56 led.

Flat and recessed spotlights for concrete pools. All accessories for installation and functioning are included. The model PO300W enclose halogen bulb that can be changed by a PAR56 LED bulb.

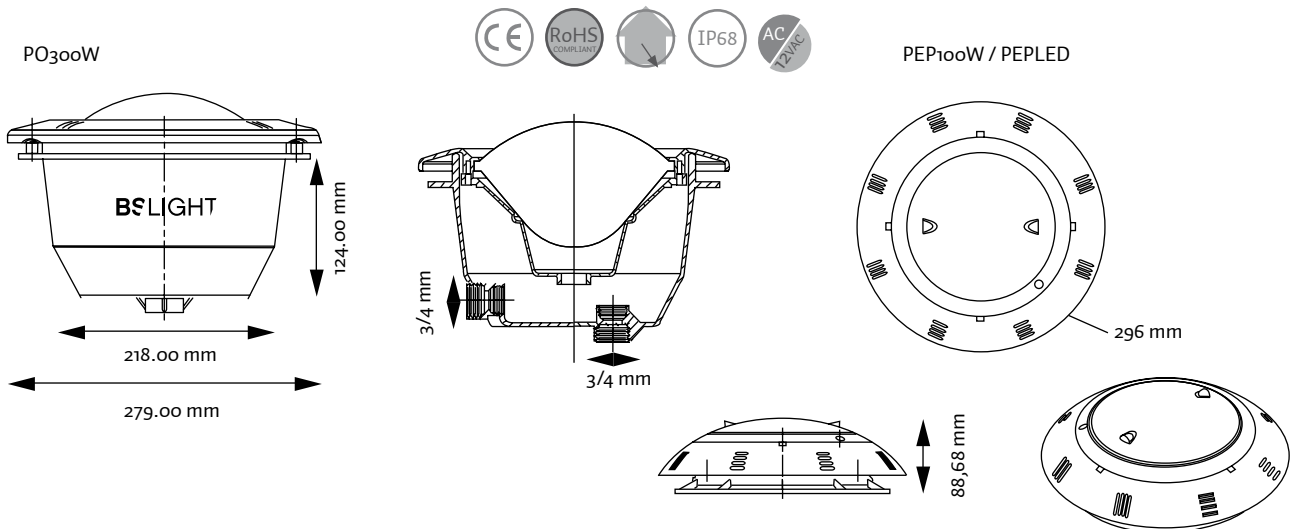

REFERENCIA REFERENCE	COLOR COLOR	ALIMENTACIÓN POWER SUPPLY	TIPO LED LED TYPE	FLUJO LUM. LUM. FLOW	FORMATO FORMAT	POTENCIA POWER	CONEXIÓN CONNECTION
PEPLEDHP		12V AC	24 LEDS 1,2W	1600lm	Plano/Flat	35W	Cables / Wires
PEPLEDHPB		12V AC	27 LEDS 1,2W	1800lm	Plano/Flat	35W	Cables / Wires
PEPLED252		12V AC	252 LEDS 5mm	900lm	Plano/Flat	25W	Cables / Wires
PEPLED252B		12V AC	195 LEDS 5mm	1200lm	Plano/Flat	25W	Cables / Wires
PO300W		12V AC	Halógena/Halogen 300W	2000lm	Empotrar/ Recessed	300W	Cables / Wires
PEP100W		12V AC	Halógena/Halogen 100W	670lm	Plano/Flat	100W	Cables / Wires

05

ILUMINACIÓN

INTERIOR

INDOOR

LIGHTING



96 /

PANELES LED REDONDOS ROUND LED PANEL

Paneles LED ultrafino redondo de medidas desde 135 a 240mm de diámetro ideales para su instalación en oficinas y comercios para la sustitución de los clásicos paneles fluorescentes. Arranque instantáneo sin parpadeo ni ruidos. Permite ser regulado.

Se pueden instalar en falso techo, en montaje en superficie o colgantes.

Ultrafine LED panel from 135mm to 240mm be installed in offices and stores for direct replacement of the fluorescent luminaries. Instant starting without blinking and noises. Can be regulated. Can be installed in ceiling roof, surface or hanging.

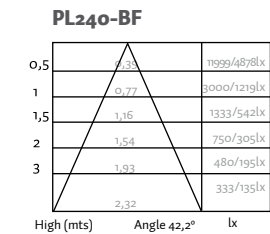
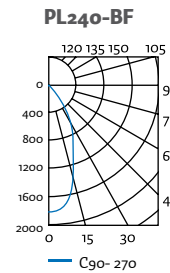
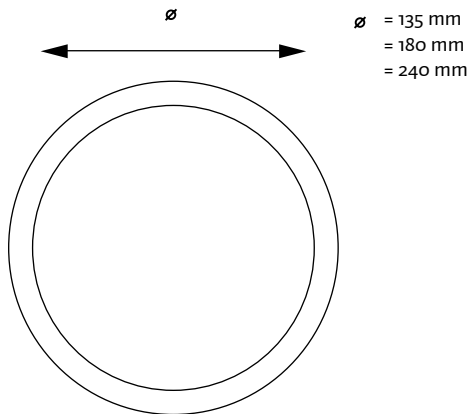

COMPARATIVA
COMPARATIVE
LED5W = 20W PL
LED8W = 30W PL
LED10W = 38W PL

REFERENCIA REFERENCE	COLOR COLOR	TEMP. TEMP.	ALIMENTACIÓN POWER SUPPLY	MEDIDAS MEASURE	TIPO DE LED LED TYPE	FLUJO LUM. LUM. FLOW	CONSUMO CONSUME
PL135BF	White	6000°	90-240V AC	ø135mm	3528 85lm/W	260lm	5W
PL135BD	Yellow	4000°	90-240V AC	ø135mm	3528 85lm/W	280lm	5W
PL135BC	Orange	3000°	90-240V AC	ø135mm	3528 85lm/W	300lm	5W
PL180BF	White	6000°	90-240V AC	ø180mm	3528 85lm/W	450lm	8W
PL180BD	Yellow	4000°	90-240V AC	ø180mm	3528 85lm/W	500lm	8W
PL180BC	Orange	3000°	90-240V AC	ø180mm	3528 85lm/W	530lm	8W
PL240BF	White	6000°	90-240V AC	ø240mm	3528 85lm/W	680lm	10W
PL240BD	Yellow	4000°	90-240V AC	ø240mm	3528 85lm/W	750lm	10W
PL240BC	Orange	3000°	90-240V AC	ø240mm	3528 85lm/W	780lm	10W



97 /

PANELES LED LED PANEL

Paneles LED ultrafino de medidas desde 30x30 hasta 120x60 ideales para su instalación en oficinas y comercios para la sustitución de los clásicos paneles fluorescentes. Arranque instantáneo sin parpadeo ni ruidos. Permite ser regulado.

Se pueden instalar en falso techo, en montaje en superficie o colgantes.

Ultrafine LED panel from 30x30 to 120x60 to be installed in offices and stores for direct replacement of the fluorescent luminaries. Instant starting without blinking and noises. Can be regulated. Can be installed in ceiling roof, surface or hanging.

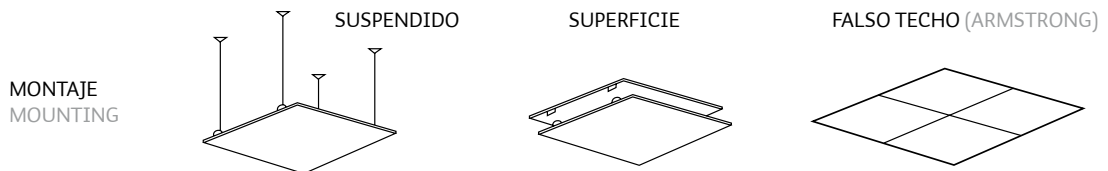
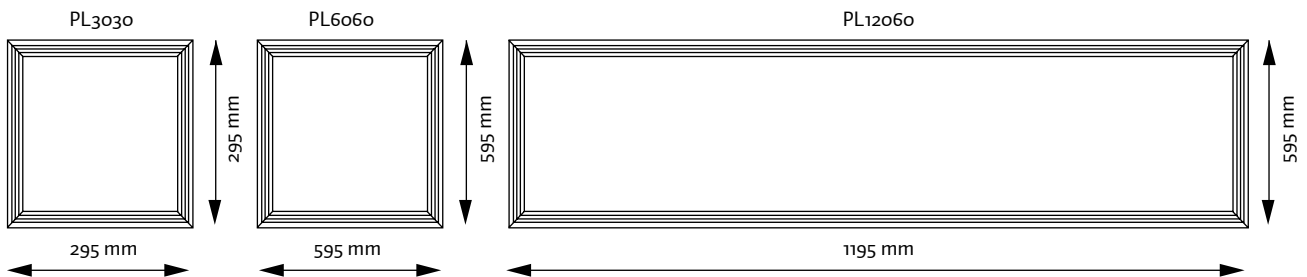

REFERENCIA REFERENCE	COLOR COLOR	TEMP. TEMP.	ALIMENTACIÓN POWER SUPPLY	MEDIDAS MEASURE	TIPO DE LED LED TYPE	FLUJO LUM. LUM. FLOW	CONSUMO CONSUME
PL3030BF	White	6000°	90-240V AC	295x295x11mm	224 LEDs 3014	1550lm	25W
PL3030BD	Yellow	4000°	90-240V AC	295x295x11mm	224 LEDs 3014	1700lm	25W
PL3030BC	Orange	3000°	90-240V AC	295x295x11mm	224 LEDs 3014	1850lm	25W
PL6060BF	White	6000°	90-240V AC	595x595x11mm	444 LEDs 3014	3300lm	48W
PL6060BD	Yellow	4000°	90-240V AC	595x595x11mm	444 LEDs 3014	3500lm	48W
PL6060BC	Orange	3000°	90-240V AC	595x595x11mm	444 LEDs 3014	3700lm	48W
PL12060BF	White	6000°	90-240V AC	595x1195x11mm	576 LEDs 3014	3950lm	65W
PL12060BD	Yellow	4000°	90-240V AC	595x1195x11mm	576 LEDs 3014	4200lm	65W
PL12060BC	Orange	3000°	90-240V AC	595x1195x11mm	576 LEDs 3014	4450lm	65W



98 /

ARO ULTRAFINO ULTRAFINE RINGS

Aros ultrafinos de superficie con 9 leds 3528 o 6 leds 5050 Blanco y RGB con cable y conectores. Incluye accesorios de instalación.
Surface ultra-thin rings with 9 LEDs white and RGB with cables and connectors. Installation accessories included.

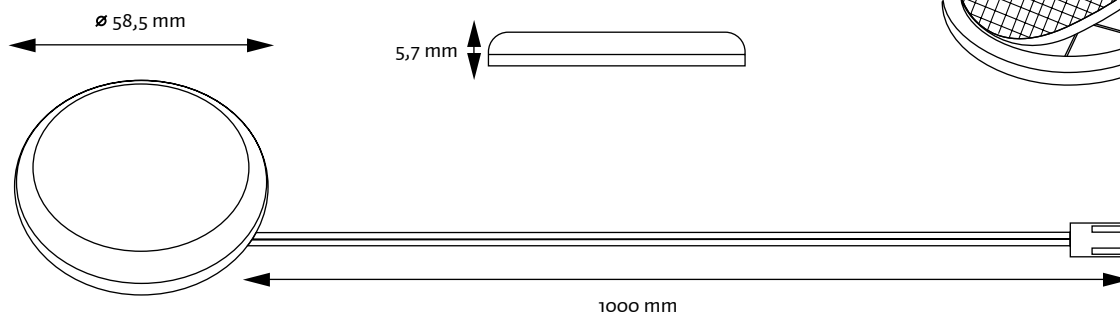

REFERENCIA REFERENCE	COLOR COLOR	TEMPERATURA TEMPERATURE	TIPO LED LED TYPE	ALIMENTACIÓN POWER SUPPLY	FLUJO LUM. LUM. FLOW	ÁNGULO ANGLE	CONSUMO CONSUME
ARO9BFC	White	6000°K	9 LEDS x 3528	12V DC	43,2lm	120°	0,8W
ARO9BCC	Yellow	3000°K	9 LEDS x 3528	12V DC	39,6lm	120°	0,8W
ARO6X3BFC	White	6000°K	6 LEDS x 5050	12V DC	84lm	120°	1,6W
ARO6X3BCC	Yellow	3000°K	6 LEDS x 5050	12V DC	78lm	120°	1,6W
ARO6RGBC	RGB	RGB	6 LEDS x 5050	12V DC	49lm	120°	1,6W

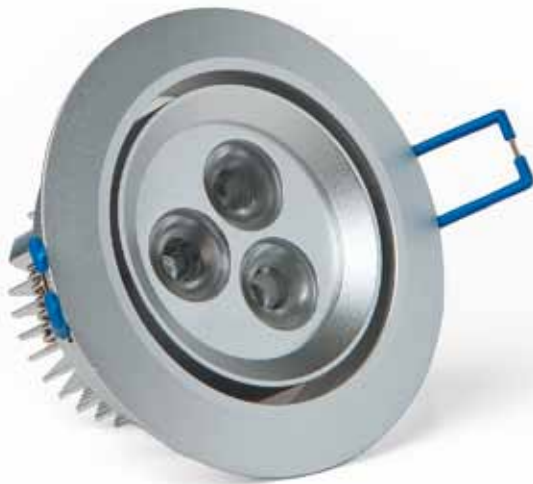

AEA3X1



AEB1W



AEC1W

99 /

AROS EMPOTRAR RECESSED RINGS

Aros para empotrar de 1 o 3 LEDS para aplicaciones en interiores. Cuerpo de aluminio y base móvil para poder dirigir el haz de luz. Aros de 52 o 80mm de diámetro.

Recessed rings of 1 or 3 LEDS to Indoor installation. Aluminum section and movable base to direct the light beam. 52 or 80mm diameter rings.

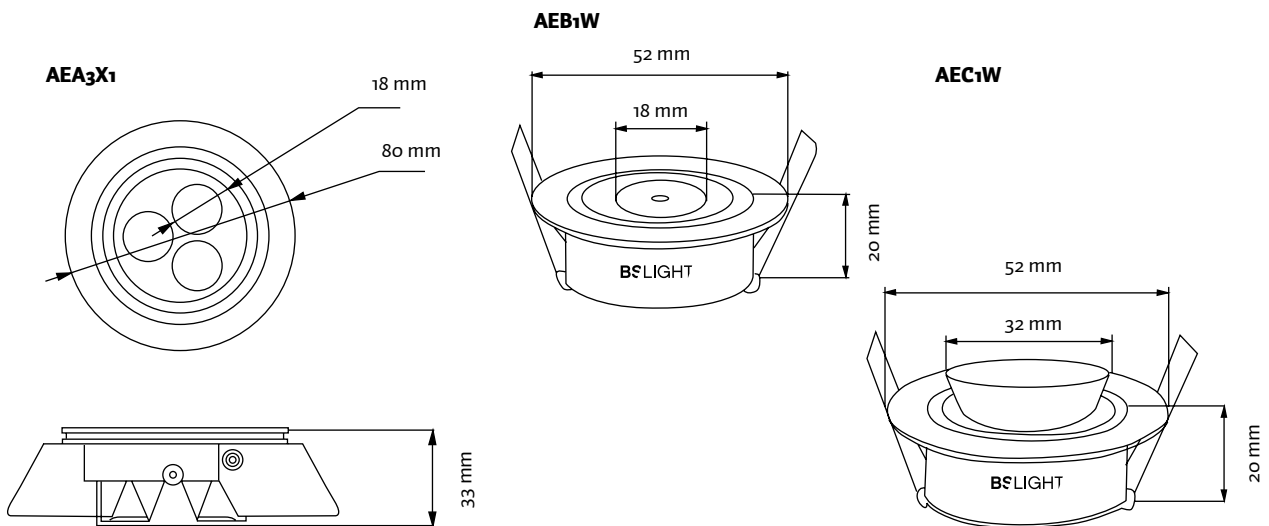

REFERENCIA REFERENCE	COLOR COLOR	TIPO LED LED TYPE	ALIMENTACIÓN POWER SUPPLY	DIMENSIÓN DIMENSIONS	FLUJO LUM. LUM. FLOW	POTENCIA POWER
AEA3X1WBF	White	3 LEDS de/of 1W	12V DC	80mm	115lm	4W
AEA3X1WBC	Yellow	3 LEDS de/of 1W	12V DC	80mm	98lm	4W
AEB1WBF	White	1 LED de/of 1W	12V DC	52mm	58lm	1,5W
AEB1WBC	Yellow	1 LED de/of 1W	12V DC	52mm	46lm	1,5W
AEC1WBF	White	1 LED de/of 1W	12V DC	52mm	58lm	1,5W
AEC1WBC	Yellow	1 LED de/of 1W	12V DC	52mm	46lm	1,5W



100 /

AROS EMPOTRAR COB DOWNLIGHT COB

Aros downlight de uso profesional para empotrar en techo. Montado con LED COB de 5W a 15W. Cuerpo de aluminio con acabado blanco o níquel satinado. Posibilidad de montar driver regulable. Grado de protección IP44.

Professional downlight to recessed ceiling. Mounted with COB LED 5W to 15W. Aluminum section with white or satin nickel finish. Ability to mount adjustable driver. Degree of protection IP44.

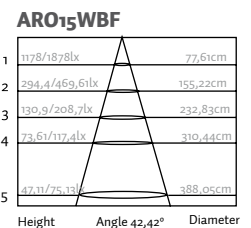
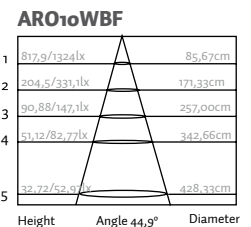
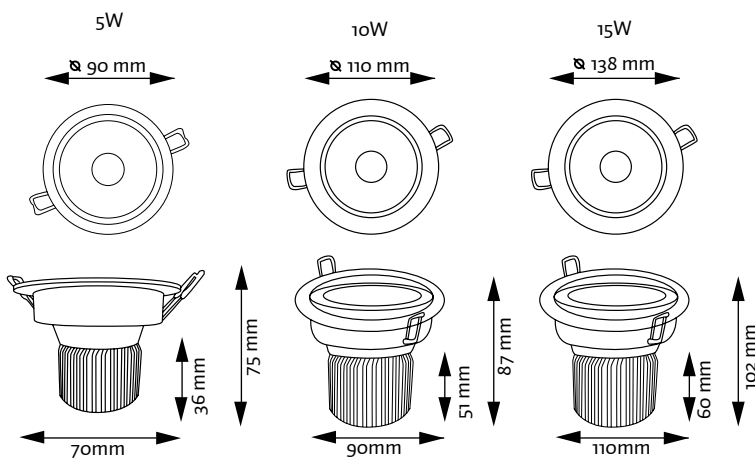

COMPARATIVA
COMPARATIVE
COB 10W = 2x13 CFL
COB 15W = 2x18 CFL
COB 25W = 2x26 CFL

REFERENCIA REFERENCE	COLOR COLOR	TEMP. TEMP.	ALIMENTACIÓN POWER SUPPLY	ÁNGULO ANGLE	TIPO DE LED LED TYPE	FLUJO LUM. LUM. FLOW	CONSUMO CONSUME
ARO5WBF	White	6400°	105-240VAC	60°	COB 5W	600lm	9W
ARO5WBD	Yellow	4200°	105-240VAC	60°	COB 5W	570lm	9W
ARO5WBC	Orange	3000°	105-240VAC	60°	COB 5W	550lm	9W
ARO10WBF	White	6400°	105-240VAC	60°	COB 10W	1050lm	14W
ARO10WBD	Yellow	4200°	105-240VAC	60°	COB 10W	1030lm	14W
ARO10WBC	Orange	3000°	105-240VAC	60°	COB 10W	1000lm	14W
ARO15WBF	White	6400°	105-240VAC	60°	COB 15W	1500lm	19W
ARO15WBD	Yellow	4200°	105-240VAC	60°	COB 15W	1470lm	19W
ARO15WBC	Orange	3000°	105-240VAC	60°	COB 15W	1450lm	19W



101 /

AROS EMPOTRAR COB ORIENTABLES ADJUSTABLE DOWNLIGHT COB

Aros downlight orientable de uso profesional para empotrar en techo. Montado con LED COB de 20W a 40W. Cuerpo de aluminio con acabado blanco o níquel satinado. Posibilidad de montar driver regulable. Grado de protección IP44.

Professional adjustable downlight to recessed ceiling. Mounted with COB LED 20W to 40W. Aluminum section with white or satin nickel finish. Ability to mount adjustable driver. Degree of protection IP44.



20W - 30W - 40W

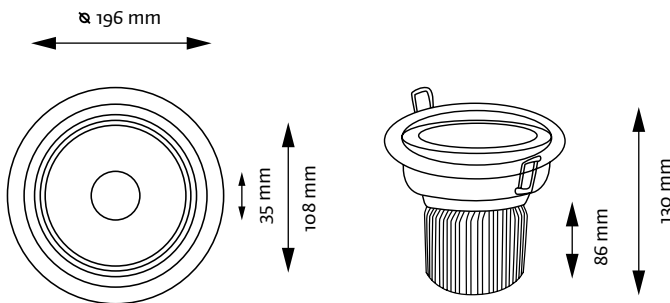

ARO20WBF

1	1509/2435lx	77,51cm
2	377,2/608,9lx	155,01cm
3	167,7/270,6lx	232,52cm
4	94,31/152,2lx	310,03cm
5	60,36/97,4lx	387,53cm

Height Angle 42,37° Diameter

ARO40WBF

1	2695/4361lx	82,25cm
2	673,7/1090lx	164,49cm
3	299,4/484,6lx	246,74cm
4	168,4/272,6lx	328,98cm
5	107,8/174,5lx	411,23cm

Height Angle 44,71° Diameter

COMPARATIVA
COMPARATIVE
COB 15W = 2x18 CFL
COB 25W = 2x26 CFL
COB 30W = 2x32 CFL

REFERENCIA REFERENCE	COLOR COLOR	TEMP. TEMP.	ALIMENTACIÓN POWER SUPPLY	ÁNGULO ANGLE	TIPO DE LED LED TYPE	FLUJO LUM. LUM. FLOW	CONSUMO CONSUME
ARO20WBF	White	6400°	105-240V AC	80°	COB 20W	2000lm	25W
ARO20WBD	Yellow	4200°	105-240V AC	80°	COB 20W	1900lm	25W
ARO20WBC	Blue	3000°	105-240V AC	80°	COB 20W	1800lm	25W
ARO30WBF	White	6400°	105-240V AC	80°	COB 30W	2500lm	35W
ARO30WBD	Yellow	4200°	105-240V AC	80°	COB 30W	2400lm	35W
ARO30WBC	Blue	3000°	105-240V AC	80°	COB 30W	2300lm	35W
ARO40WBF	White	6400°	105-240V AC	80°	COB 40W	3200lm	45W
ARO40WBD	Yellow	4200°	105-240V AC	80°	COB 40W	3100lm	45W
ARO40WBC	Blue	3000°	105-240V AC	80°	COB 40W	3000lm	45W



102 /

DOWNLIGHT PROFESIONAL PROFESSIONAL DOWNLIGHT

Dowlight de uso profesional para empotrar en techo. Montado con LED COB de 15W o 25W.
Cuerpo de aluminio con acabado blanco o níquel satinado. Posibilidad de montar driver regulable. Grado de protección IP54.
Professional Dowlight to be recessed in ceiling. Assembled with COB LED 15w or 25w
Aluminium section and white or satin nickel finished. It's possible to assemble regular driver. IP54

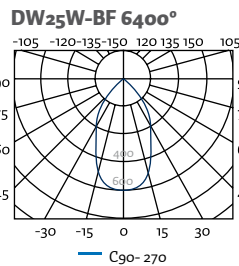
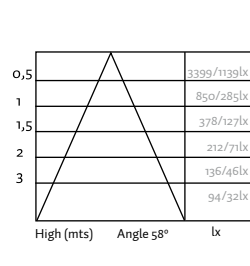
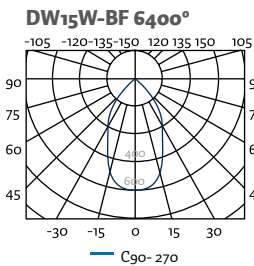
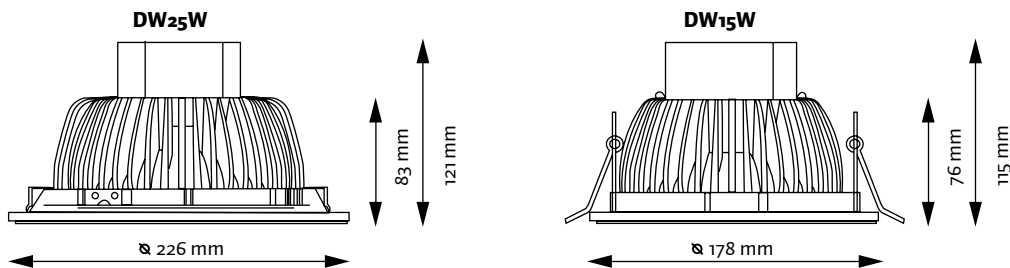

COMPARATIVA
COMPARATIVA
COB 15W = 2x18 CFL
COB 25W = 2x26 CFL

REFERENCIA REFERENCE	COLOR COLOR	TEMP. TEMP.	ALIMENTACIÓN POWER SUPPLY	ÁNGULO ANGLE	TIPO DE LED LED TYPE	FLUJO LUM. LUM. FLOW	CONSUMO CONSUME
DW15W-BF	White	6400°	220-240V AC	45°	COB 15W	1125lm	20W
DW15W-BD	Yellow	4200°	220-240V AC	45°	COB 15W	1050lm	20W
DW15W-BC	Orange	3000°	220-240V AC	45°	COB 15W	975lm	20W
DW25W-BF	White	6400°	220-240V AC	58°	COB 25W	1840lm	30W
DW25W-BD	Yellow	4200°	220-240V AC	58°	COB 25W	1630lm	30W
DW15W-BC	Orange	3000°	220-240V AC	58°	COB 25W	1620lm	30W



103 /

FOCO DE CARRIL PROFESIONAL PROFESSIONAL TRACK LIGHT

Foco de carril de uso profesional. Montado con LED COB de 25W o 30W de la marca Bridgelux. Cuerpo de aluminio con acabado blanco con aro en negro. Giro completo en todas las direcciones.

Professional Track Sport Light. COB LED 25W or 30W mounted. Bridgelux brand. Aluminium section with white finished and black ring. Full rotation in all directions

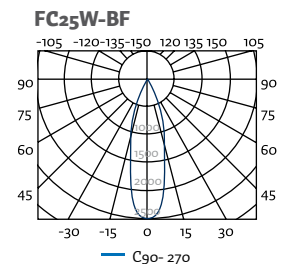
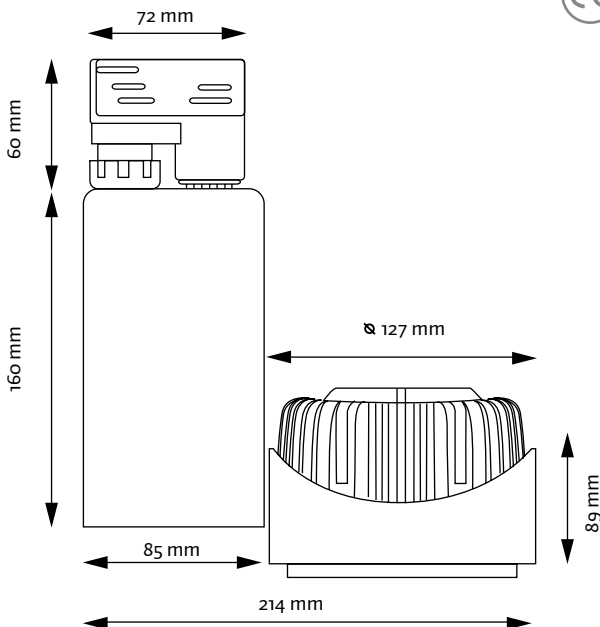

FC25W-BF

High (mts)	Angle 25,8°	lx
0,5	0,23	4682/784clx
1	0,46	4213/1960lx
1,5	0,69	1872/871lx
2	0,92	1053/490lx
3	1,37	674/314lx
	1,37	468/218lx

COMPARATIVA
COMPARATIVE
COB 15W = 2x18 CFL
COB 25W = 2x26 CFL

REFERENCIA REFERENCE	COLOR COLOR	TEMP. TEMP.	ALIMENTACIÓN POWER SUPPLY	ÁNGULO ANGLE	TIPO DE LED LED TYPE	FLUJO LUM. LUM. FLOW	CONSUMO CONSUME
FC25W-BF	White	5600°	220-240V AC	26°	COB 25W	1345lm	30W
FC25W-BD	Yellow	4000°	220-240V AC	26°	COB 25W	1250lm	30W
FC25W-BC	Yellow	3000°	220-240V AC	26°	COB 25W	1135lm	30W
FC30W-BF	White	5600°	220-240V AC	26°	COB 30W	1740lm	35W
FC30W-BD	Yellow	4000°	220-240V AC	26°	COB 30W	1600lm	35W
FC30W-BC	Yellow	3000°	220-240V AC	26°	COB 30W	1530lm	35W



LC1X24W-BF

LC2X24W-BF

LC3X24W-BF

104 /

LUMINARIA TIPO CARDAN RECESSED LUMINAIRE

Luminaria de empotrar orientable a 360° mediante sistema cardan. Fabricado en aluminio con acabado en color gris metalizado.
Recessed luminaire with 360° swivel gimbal system. Made in aluminum with metallic gray finish.

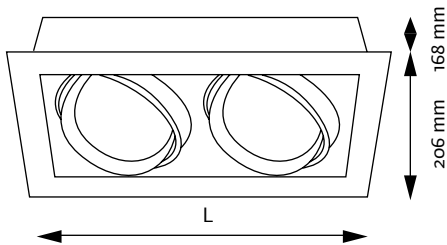

L = 206mm 1X24W
L = 358mm 2X24W
L = 508mm 3X24W

LC1X24W-BF 6400°

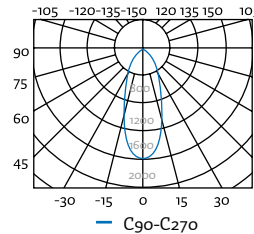

High (mts)	Angle 42,00°	lx
0,5	1,31	1071/452lx
1	0,77	2768/1131lx
1,5	1,15	1230/502lx
2	1,54	692/283lx
3	1,92	443/181lx
2,30		308/126lx

LC2X24W-BF 6400°

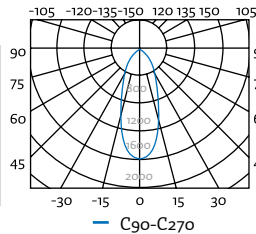

High (mts)	Angle 42,00°	lx
0,5	2,35	2241/904lx
1	0,77	5535/2261lx
1,5	1,15	3460/1005lx
2	1,54	1384/565lx
3	1,92	886/362lx
2,30		615/251lx

LC3X24W-BF 6400°

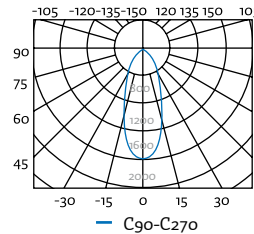

High (mts)	Angle 42,00°	lx
0,5	4,31	3332/1356lx
1	0,77	8303/3392lx
1,5	1,15	3690/1507lx
2	1,54	2076/848lx
3	1,92	1328/543lx
2,30		923/377lx

COMPARATIVA
COMPARATIVE
COB 15W = 2x18 CFL
COB 25W = 2x26 CFL

REFERENCIA REFERENCE	COLOR COLOR	TEMP. TEMP.	ALIMENTACIÓN POWER SUPPLY	ÁNGULO ANGLE	TIPO DE LED LED TYPE	FLUJO LUM. LUM. FLOW	CONSUMO CONSUME
LC1X24W-BF	White	6400°	85-264V AC	42°	COB 24W	1650lm	30W
LC1X24W-BD	Yellow	4200°	85-264V AC	42°	COB 24W	1600lm	30W
LC1X24W-BC	Yellow	3000°	85-264V AC	42°	COB 24W	1550lm	30W
LC2X24W-BF	White	6400°	85-264V AC	42°	2 x COB 24W	3300lm	60W
LC2X24W-BD	Yellow	4200°	85-264V AC	42°	3 x COB 24W	3200lm	60W
LC2X24W-BC	Yellow	3000°	85-264V AC	42°	2 x COB 24W	3100lm	60W
LC3X24W-BF	White	6400°	85-264V AC	42°	3 x COB 24W	4950lm	90W
LC3X24W-BD	Yellow	4200°	85-264V AC	42°	3 x COB 24W	4800lm	90W
LC3X24W-BC	Yellow	3000°	85-264V AC	42°	3 x COB 24W	4650lm	90W

06

ILUMINACIÓN

INDUSTRIAL

INDUSTRIAL

LIGHTING



106 /

CAMPANAS INDUSTRIALES HASTA 100W LED HIGH BAY LIGHT UNTIL 100W

Campanas Industriales de 80 y 100W para la sustitución directa de las tradicionales campanas de mercurio alta presión o de sodio mejorando el rendimiento y obteniendo unos grandes ahorros energéticos. Montado con LEDs Philips Lumileds Luxeon y con driver de la marca Meanwell. Se ofrecen diferentes alternativas en temperatura de color y ángulos de iluminación.

High bay light 80 and 100w to be replaced the traditional high-pressure mercury or sodium lamps. Improved the energy efficiency and get energy saving. LED Philips Lumileds Luxeon assembled with Meanwell drivers. You can choose from several options like color temperature and light angle.



80W

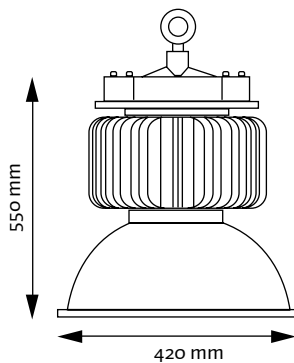

C-80W

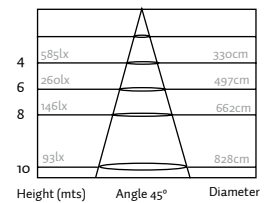
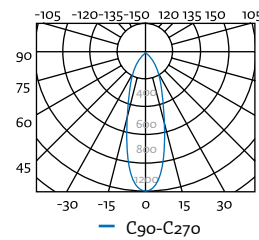

100W

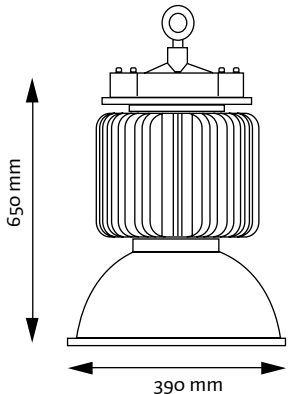

C-100W

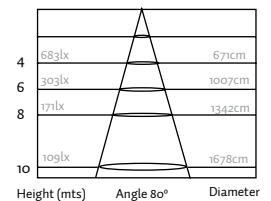
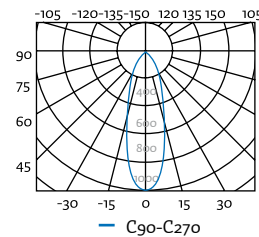

COMPARATIVA
COMPARATIVE
COB80W = 150W MH
COB100W = 200W MH

REFERENCIA REFERENCE	TEMP. TEMP.	ÁNGULO ANGLE	ALIMENTACIÓN POWER SUPPLY	MEDIDAS MEASURE	TIPO DE LED LED TYPE	FLUJO LUM. LUM. FLOW	CONSUMO CONSUME
C-80W-XX-XX	4000° - 7000°	45°/80°/100°	90-260V AC	Ø420x550mm	Philips 80W	7000lm	95W
C-100W-XX-XX	4000° - 7000°	80°/100°	90-260V AC	Ø390x650mm	Philips 100W	9000lm	110W



107 /

CAMPANAS INDUSTRIALES HASTA 200W LED HIGH BAY LIGHT UNTIL 200W

Campanas Industriales de 150 y 200W para la sustitución directa de las tradicionales campanas de mercurio alta presión o de sodio mejorando el rendimiento y obteniendo unos grandes ahorros energéticos. Montado con LEDs Philips Lumileds Luxeon y con driver de la marca Meanwell. Se ofrecen diferentes alternativas en temperatura de color y ángulos de iluminación.

High bay light of 150 and 200w to replace the traditional high-pressure mercury or sodium lamps. Improved the energy efficiency and get energy saving. LED Philips Lumileds Luxeon assembled with Meanwell drivers. You can choose from several options like color temperature and illumination angle.



150W

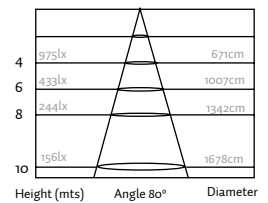
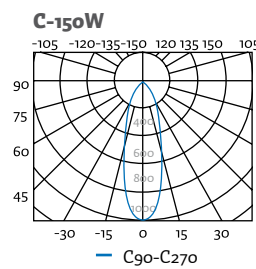
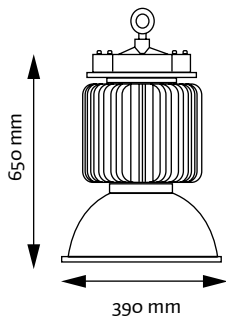

200W

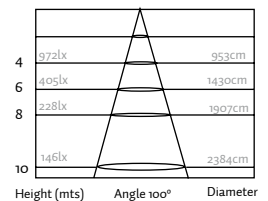
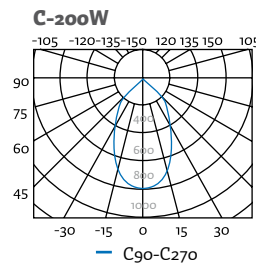
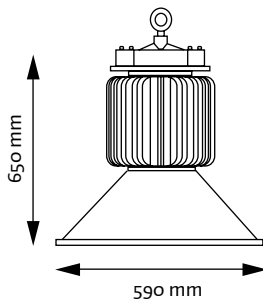

COMPARATIVA
COMPARATIVE
COB150W = 250W MH
COB200W = 400W MH

REFERENCIA REFERENCE	TEMP. TEMP.	ÁNGULO ANGLE	ALIMENTACIÓN POWER SUPPLY	MEDIDAS MEASURE	TIPO DE LED LED TYPE	FLUJO LUM. LUM. FLOW	CONSUMO CONSUME
C-150W-XX-XX	4000° - 7000°	80°/100°	90-260V AC	Ø390x650mm	Philips 150W	13000lm	170W
C-200W-XX-XX	4000° - 7000°	80°/100°	90-260V AC	Ø590x650mm	Philips 200W	18000lm	220W



108 /

PROYECTORES HASTA 50W FLOOD LIGHT UNTIL 50W

Proyectores en carcasa de aluminio con protección IP65 de 10W a 50W ideales para iluminación de fachadas y edificios. Incorpora LED tipo COB con alimentador interno para funcionamiento a 230V AC.

IP65 Aluminum housing spotlights from 10w to 50W, destined for outdoors and building illumination. COB LED and internal supply to work 230V AC.



PR10WCOB

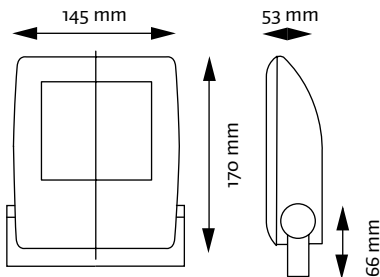

PR30WCOB

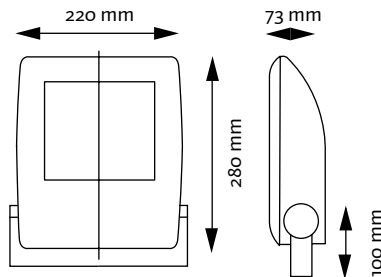

PR50WCOB

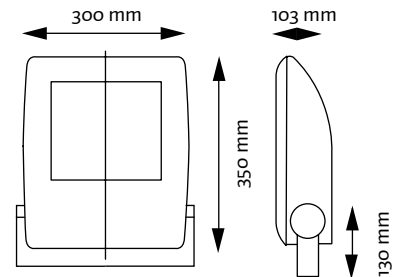

REFERENCIA REFERENCE	TEMP. TEMP.	ÁNGULO ANGLE	ALIMENTACIÓN POWER SUPPLY	MEDIDAS MEASURE	TIPO DE LED LED TYPE	FLUJO LUM. LUM. FLOW	CONSUMO CONSUME
PR10WCOB	2700-7000°K	120°	220-240V AC	170x145x53mm	1 COB 10W	800lm (6000°)	15W
PR30WCOB	2700-7000°K	120°	220-240V AC	280x220x73mm	1 COB 30W	2400lm (6000°)	35W
PR50WCOB	2700-7000°K	120°	220-240V AC	350x300x103mm	1 COB 50W	4000lm (6000°)	55W



109 /

LUMINARIA URBANA 56W STREET LIGHT 56W

Luminaria para uso urbano con 56 LEDS HP. Carcasa de aluminio de alta resistencia con grado de protección IP65. Ideales para iluminación de vías residenciales en báculos de baja altura. Fácil instalación, se adaptan a báculos estándar de tubo 60mm.

Street light with 56 LEDS HP. Aluminum housing with high strength IP65. Ideal for lighting residential streets in low-rise staffs. Easy Installation, adapt to standard staff of pipe 60mm.

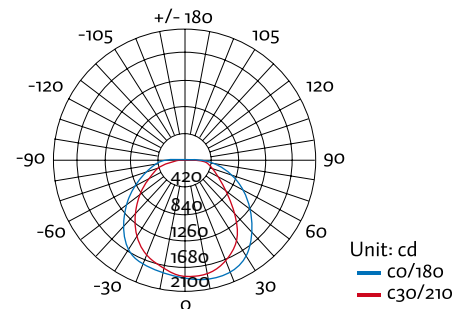
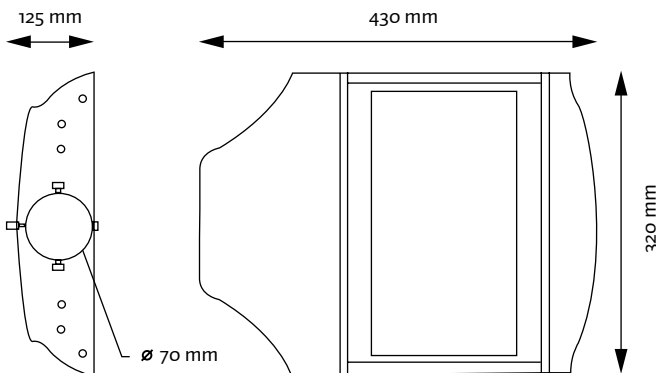

H m	lx
2,5	322,59
5,0	80,65
7,5	35,84
10	20,16
10	12,90

■ Co-C180
■ C90-C270

REFERENCIA REFERENCE	COLOR COLOR	TEMP. TEMP.	PROTECCIÓN PROTECTION	ALIMENTACIÓN POWER SUPPLY	ÁNGULO ANGLE	TIPO DE LED LED TYPE	FLUJO LUM. LUM. FLOW	CONSUMO CONSUME
FU-56W-BF	■	6000°K	IP65	85-264V AC	120°	56 LED 1W HP	5443lm	65W



110 /

LUMINARIA URBANA 98W STREET LIGHT 98W

Luminaria para uso urbano con 98 LEDS HP. Carcasa de aluminio de alta resistencia con grado de protección IP65. Ideales para iluminación de vías residenciales en báculos de media altura. Fácil instalación, se adaptan a báculos estándar de tubo 60mm
Street light with 98 LEDS HP. Aluminum housing with high strength IP65. Ideal for lighting residential streets in half-height staffs. Easy Installation, adapt to standard staff of pipe 60mm.

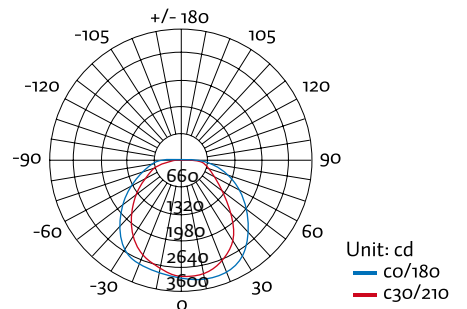
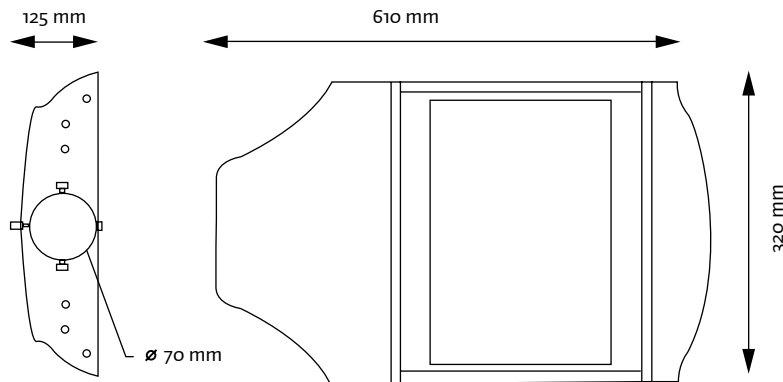

H m	lx
2,5	568,10
5,0	141,45
7,5	63,25
10	33,56
10	22,88

■ Co-C180
■ C90-C270

REFERENCIA REFERENCE	COLOR COLOR	TEMP. TEMP.	PROTECCIÓN PROTECTION	ALIMENTACIÓN POWER SUPPLY	ÁNGULO ANGLE	TIPO DE LED LED TYPE	FLUJO LUM. LUM. FLOW	CONSUMO CONSUME
FU-98W-BF	■	6000°K	IP65	85-264V AC	120°	98 LED 1W HP	10.165lm	110W



111 /

LUMINARIA URBANA 126W STREET LIGHT 126W

Luminaria para uso urbano con 126 LEDS HP. Carcasa de aluminio de alta resistencia con grado de protección IP65. Ideales para iluminación de vías residenciales en báculos de baja altura. Fácil instalación, se adaptan a báculos estándar de tubo 60mm
Street light with 126 LEDS HP. Aluminum housing with high strength IP65. Ideal for lighting residential streets in low-rise staffs. Easy Installation, adapt to standard staff of pipe 60mm.

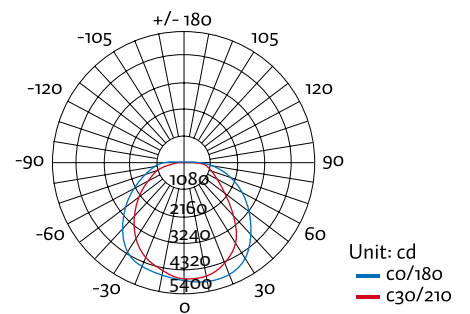
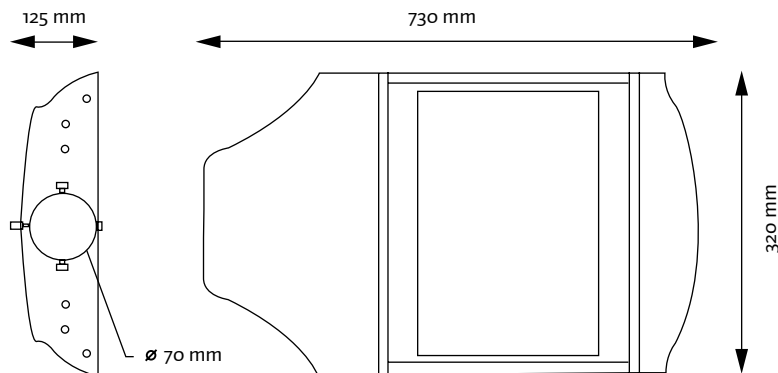

Unit: cd
— C0/180
— C30/210

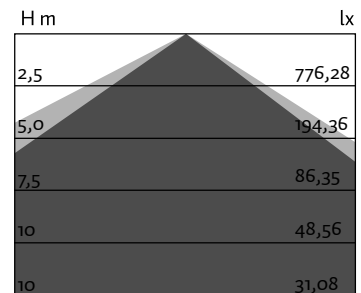

■ Co-C180
■ C90-C270

REFERENCIA REFERENCE	COLOR COLOR	TEMP. TEMP.	PROTECCIÓN PROTECTION	ALIMENTACIÓN POWER SUPPLY	ÁNGULO ANGLE	TIPO DE LED LED TYPE	FLUJO LUM. LUM. FLOW	CONSUMO CONSUME
FU-126W-BF	■	6000°K	IP65	85-264V AC	120°	126 LED 1W HP	13300lm	140W

CONSEJOS TÉCNICOS DE INSTALACIÓN

INSTALLATION TECHNICAL ADVICES

Los LEDS, son muy sensibles a la electricidad estática. No sacarlo de su embalaje hasta el momento de realizar la instalación. Evitar tocarlos con las manos sobre todo si trabajamos con plásticos o metacrilatos.

LEDS are very sensitive to static electricity. Do not unpack until the installation. Avoid touch it with your hands, especially if you work with plastic or methacrylate.

No aplicar más del 80% de la carga máxima sobre los alimentadores, controladores o amplificadores por lo que si un equipo es de 100W, no se le puede aplicar una carga superior a 80W.

Do not connect more than 80 % of the maximum charge on the power devices, controllers or amplifiers. If your equipment consume is 100W, it cannot connect with more than 80W.

No alejar los alimentadores a más de 3mts del inicio de la instalación de LEDs a fin de evitar caídas de tensión.

Do not place the power devices over 3mts from the beginning of the LED installation to avoid drop.

Respetar siempre la polaridad de los cables (+/-).

Respect the polarity wires (+/-) always

Para evitar caídas de tensión no se deberá conectar en serie derivaciones superiores a 30W aunque si la instalación se realiza en circuito cerrado (alimentando al inicio y al final con la misma fuente de alimentación) se puede conseguir derivaciones de hasta 50W.

To avoid drop do not connect in serial branches up to 30W. If the installation is in closed circuit (same power supply at the beginning and at the end) it is possible to connect until 50W branches.

En los alimentadores (FT) con más de un puerto (V+V+ V-V-) se deberá repartir la carga a partes iguales entre cada uno de ellos.

Have to be equally distributed between themselves in the power supply (FT) with more than one port (V+V+ V-V-).

Todos los equipos RGB (TF, TR, M, etc) se deberán controlar a través de controladores serie CVRRGB.

All the RGB equipments (TF, TR, M, etc) have to be controlled by a CVRRGB serial controllers.

Respetar las distancias máximas de conexión de tiras monocolor o RGB. Utilizar varias fuentes o amplificadores de señal si se precisa. Consulte su instalación con el personal de BSV si lo cree necesario.

Respect the maximum connection distances of the RGB or single-color strips. Use several power supply or amplifier if it is necessary. Contact to BSV Electronic if you have any question.

La conexión de los LEDS alimentados con alimentadores de corriente constante (FC) se deberá realizar en serie. La conexión de los LEDS alimentados con alimentadores de tensión constante (FT) se deberá realizar en paralelo.

The installation of LED with constant current power devices (FC) must be serial connected. The installation of LED with Constant Tension power devices (FT) must be connected in parallel.









Cuando se instala Tiras Flexibles (TF) tener en cuenta que es necesaria una manipulación cuidadosa a fin de evitar roturas en su circuito impreso flexible.

Be careful with the flexible strips (TF) installation, to avoid scratches on the circuit

Cuando se instala Tira Flexible IP68 (TF-IP68) tener en cuenta que estas tiras estancas, dejan de serlo en el momento que se corte. Para mantener la estanqueidad se deberá aplicar un producto aislante en la zona del corte.

When you install the IP68 flexible strip (TF-IP68) remember that these waterproof strips are not waterproof anymore once you cut it. You need to apply an insulating product in cut zone to keep the water proof level.

LEYENDA DE ICONOS ICONS LEGEND

	Color del LED rojo / Red LED colour
	Color del LED ambar / Yellow LED colour
	Color del LED azul / Blue LED colour
	Color del LED verde / Green LED colour
	Color del LED blanco frío 6000°K / Cold white LED colour 6000°K
	Color del LED blanco neutro 4000°K / Neutral white LED colour 4000°K
	Color del LED blanco cálido 3000°K / Warm white LED colour 3000°K
	Color LED RGB / RGB LED colour

	Cumple con la normativa Europea CE / To fulfill CE		Material sensible a la electricidad estática. Evitar tocar con los dedos / Material sensitive to static electricity. Avoid to touch with fingers.
	Cumple con la normativa RoSH / To fulfill RoSH		Tensión de funcionamiento / Power supply 12VDC 12VDC/DC 24VDC 24VDC/DC 230VDC
	Uso interior / Internal use		Ángulo de apertura / Light beam 15° 20° 24° 30° 45° 60° 90° 115° 120°
	Se puede instalar en exterior It can be used outdoors		Grados de protección IP / IP protection degree IP33 IP44 IP65 IP66 IP67 IP68

ESQUEMA INSTALACIÓN MONOCOLOR SIMPLE / SINGLE- COLOUR INSTALLATION DIAGRAM

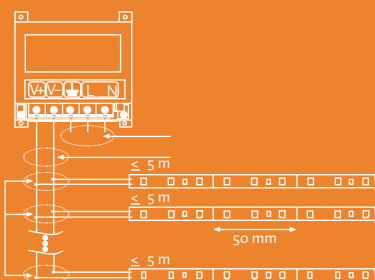

ESQUEMA INSTALACIÓN RGB SIMPLE / RGB INSTALLATION DIAGRAM

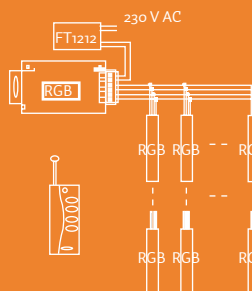

ESQUEMA INSTALACIÓN RGB CON AMPLIFICADORES / RGB INSTALLATION WITH AMPLI- FIER DIAGRAM

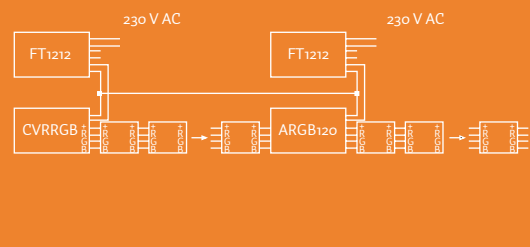

Para cualquier consulta referente a su instalación, consulte con el departamento técnico de BSV
For any question regarding your installation, consult the technical department of BSV

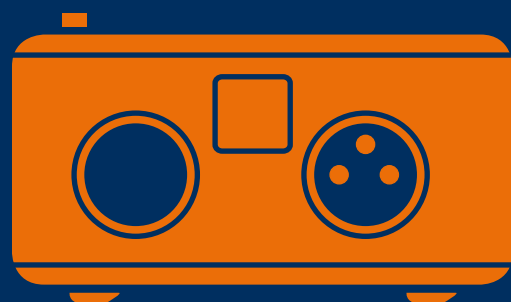
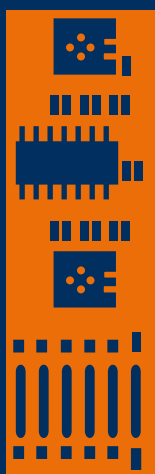

BSV.

with you since 1984

C/ Ribera del Congost, 40 · Pol.Ind. Sector V
08520 Les Franqueses del Vallès · Barcelona · Spain

Tel. (+34) 93 861 51 15 · **Fax** (+34) 93 861 52 99 · bsv@bsvelectronic.com

[www. bsvelectronic.com](http://www.bsvelectronic.com)